



Handbook for Electric Service

Work Order #: _____

Contact #: _____

Received by: _____

- Temporary Service
- Basic Service Large
- Basic Service
- Upgrade of Service

Issued: 2025





Handbook for Electric Service

New Hampshire Electric Cooperative Contact Information	2
NHEC Office Locations and Towns Served.....	3
New Service Checklist.....	4
Load Data & Meter Request Form.....	5
Section 1.....	7
General Information	
Section 2.....	11
Metering	
General	
Services Greater than 400 amp	
Section 3.....	21
Overhead Service Installations, Permanent & Temporary	
Basic & Large Basic Service	
Section 4.....	27
Underground Service Installations, Permanent & Temporary	
General Installation Requirements for Underground Facilities	
Secondary	
Primary	
Underground Checklist	
Conduit Trench Inspection Notice	
Section 5.....	54
Utilization Equipment	
Section 6.....	55
Generating Equipment	
Owned By Members General & Standby	
Generating Equipment Back-up Generator Registration Form	
Section 7.....	59
Interconnection Facility Installations and Electric Vehicle Charging Equipment	
Section 8.....	62
Glossary of Terms	

Contact Information

Construction Services Department

1-877-677-3236

Application for electric service and requests for information regarding these requirements should be made by calling our Construction Services Department; this department is open Monday thru Friday from 7:00 a.m. to 3:30 p.m.

Website

www.NHEC.com

Visit our website for all of the information provided in this Handbook.

Our Tariff, Terms and Conditions, Charges and Rates, Schedule of Fees and List of Approved Meter Sockets are also available online as well as referenced in this Handbook.

Outage Reporting

1-855-960-3075

There is a fully automated outage reporting system in place, your information can be accessed by phone number or account number. You can now view current outage information online by visiting our website at www.nhec.com.

Metering

1-800-698-2007

For Metering questions, please call Member Solutions Department.

Developments/Subdivisions

1-877-677-3236

Require a unique design, please call Construction Services Department for assistance.

Dig Safe

1-888-344-7233 or 811 or www.digsafe.com

Always call 72 hours prior to any trenching or excavation work.



NHEC Operation Centers and Towns Served

ALTON	ANDOVER	COLEBROOK	CONWAY	LISBON
Alton	Alexandria*	Clarksville	Bartlett	Bath
Barnstead	Andover	Colebrook	Conway	Benton
Belmont*	Belmont*	Columbia	Eaton	Easton
Epsom	Bristol	Dixville	Freedom	Haverhill
Farmington	Canterbury	Pittsburgh	Glen	Landaff
Gilford*	Danbury	Stewartstown	Hales Location	Lisbon
Gilmanton*	Franklin		Harts Location	Littleton
Loudon	Gilmanton*		Intervale	Lyman
New Durham	Grafton*		Jackson	Monroe
Pittsfield	Hill		Madison	Pike
	Northfield		Ossipee*	Sugar Hill
	Salisbury			
	Springfield*			
	Sutton			
	Wilmot			

MEREDITH	PLYMOUTH	RAYMOND	SUNAPEE
Brookfield	Bridgewater	Allenstown	Acworth
Center Harbor*	Campton	Auburn	Charlestown
Effingham	Canaan	Brentwood	Claremont
Holderness*	Center Harbor*	Candia	Cornish
Laconia	Dorchester	Chester	Croydon
Meredith	Ellsworth	Danville	Enfield
Moultonboro	Glenciff	Deerfield	Goshen
New Hampton*	Grafton*	Derry	Grafton
Ossipee*	Groton	Durham	Langdon
Sanbornton*	Hanover	Epping	Lempster
Sandwich*	Hebron	Epsom*	Marlow
Tamworth	Holderness*	Fremont	Meriden
Tuftonboro	Lincoln	Kingston	Newport
Wakefield	Lyme	Lee	Plainfield
Wolfeboro	New Hampton*	Londonderry	Springfield*
	Orange	Northwood	Sunapee
	Orford	Nottingham	Unity
	Piermont	Raymond	Washington
	Plymouth	Sandown	
	Rumney		
	Sandwich*		
	Thornton		
	Warren		
	Waterville		
	Wentworth		
	Woodstock		

*These towns served by multiple Operation Centers

New Service Checklist

In order to improve our efficiency, we ask that you review the information in this handbook thoroughly. Please review the following checklist to ensure that you have completed all applicable steps before calling us for your service connection.

Please be advised that in order for New Hampshire Electric Cooperative (hereinafter referred to as NHEC) to connect service, installations must meet NHEC specifications. If NHEC specifications are not met, applicable charges, per NHEC's Tariff, will apply.

- Is a foundation in place?
- Has the service entrance size been determined?
- Has a Load Data Survey Sheet been provided for all three-phase services and any single-phase service 400 amp and over? (*see page 5 of this handbook*)
- Has the choice of overhead or underground service been determined?
- Do you know the date the service is needed?
- If applicable, has the location for the temporary service been determined? (*Subject to NHEC's approval.*)
- Have you determined the location for the permanent service? (*Subject to NHEC's approval.*)
- Has the easement information been provided, (book and page number of deed, tax map and lot number, bordering lot ownership with applicable tax map and lot numbers) signed in black ink and notarized? If this is a parcel with a subdivision you must include the subdivision name in the easement.
- Has a municipal inspection been received?
- Have you made all necessary prepayments?
- Are you considering: Renewable Energy Source (PV, wind, Hydro), Electric Vehicle (EV) charging, or Battery Storage?



NEW HAMPSHIRE ELECTRIC COOPERATIVE, INC.

LOAD DATA AND METER REQUEST FORM

Please Submit for all 3 Phase Services and any Single Phase Service ≥ 400 Amps

MEMBER / CO. NAME:	MEMBER PHONE #:
MEMBER ADDRESS:	MEMBER CONTACT PERSON:
SERVICE ADDRESS:	
CONTRACTOR NAME:	CONTRACTOR PHONE#:
CONTRACTOR CONTACT PERSON:	CONTRACTOR CONTACT PHONE #:
ELECTRICAL CONTRACTOR NAME:	ELECTRICAL CONTRACTOR PHONE #:
ELECTRICAL CONTACT PERSON:	ELECTRICAL CONTACT PHONE #:

SERVICE EQUIPMENT DATA	
MAIN PANEL SIZE: _____	MAIN BREAKER SIZE: _____
<input type="checkbox"/> SINGLE PHASE: 120/240v	Three Phase 4 WIRE: <input type="checkbox"/> 120/208v <input type="checkbox"/> 277/480 Delta: <input type="checkbox"/> 3 wire <input type="checkbox"/> 4 wire

ELECTRICAL CONNECTED LOADS MUST BE REFLECTED IN KW			
LIGHTING:	WASHER:	GEO THERMAL:	<input type="checkbox"/> YES <input type="checkbox"/> NO
RECEPTACLES:	DRYER:	GEO THERMAL LARGEST MOTOR SIZE:	
SPACE HEATING:	ELEVATOR:		
WATER HEATING:	MISCELLANEOUS:		
AIR CONDITIONING:	OTHER "DESCRIBE":		
MOTORS:	EMERGENCY GENERATION?	KW: _____	
ESTIMATED DEMAND = TOTALED CONNECTED LOAD IN KW _____ X 0.8 = _____			

LARGE ELECTRICAL EQUIPMENT AND MOTORS	1 or 3 PHASE	VOLTS	HORSE POWER	RENEWABLE ENERGY DATA AND INSTALLING CONTRACTOR INFORMATION	
				RENEWABLE SOURCE PV, WIND, HYDRO	INSTALLERS NAME:
				INSTALLERS PHONE#	
				INVERTER SIZE(kW):	
				GROUP NET HOST PROJECT?	<input type="checkbox"/> YES <input type="checkbox"/> NO
				GROUP NET HOST# OF MEMBERS	_____

Form filled out by: _____ Title: _____

I certify that the information provided above on this form is accurate, and it correctly reflects the expected electrical load.

Signature: *X* _____ Date: _____

****Section Below for Internal Use Only****

Line Design Tech:							
WO #:	District:	Pole #:	Date:				
Member Account Number:		System Voltage:					
<input type="checkbox"/> 3 Ph Self Contained	<input type="checkbox"/> 1 Ph XFMR Rated ≥ 400A	<input type="checkbox"/> 3 Ph XFMR Rated ≥ 400A					
Meter Socket Mounting:	Building	XFMR	Pole	Other:			
CT Metering Method:	Primary	Secondary					
CT Mounting:	Pole Mount	Pad Mount	CT Enclosure	Other:			
Meter Dept Section:	Installer:	Co-op #	Ratio	Co-op #	Ratio		
Meter Prog #:	Meter #:	CT	VT				
Date Complete:	CT	VT					
XFMR Loss Compensation:	<input type="checkbox"/> Y <input type="checkbox"/> N	CT	VT				

Reply To: New Hampshire Electric Cooperative, Inc 579 Tenney Mtn. Highway, Plymouth, NH 03264 (877) 677-3236

Section 1: General Information

This handbook should be used only as an aid to help Members and others better understand the services available from NHEC; it has been prepared to assist you in planning your service installations. It is impractical to attempt to cover in a booklet of this type all of NHEC's approved Specifications or all of the conditions and problems which may be encountered in various installations. It is very important that these instructions and standards are adhered to in every detail. This will prevent delays and possible additional costs to you. It is the Member's responsibility to ensure that all wiring, materials and installations comply with the most recent issue of the National Electrical Code (hereinafter referred to as NEC) and any other federal, state, or local codes that apply. Where conflict(s) exists the more stringent code will apply.

- Readers are encouraged to refer to the actual text of NHEC's Bylaws, NHEC's Terms and Conditions, NHEC's Tariffs, or any relevant contract.
- The installation of a new service is a joint effort between the Member, the Contractor, and NHEC. This handbook is provided to help you become aware of our policies and practices. This should ensure a timely and cost-effective installation.
- Construction or modification of the service is subject to any fees in accordance with NHEC's Terms and Conditions and NHEC's Schedule of Fees.
- New Hampshire Electric Cooperative strives to render dependable electric service in accordance with the Tariff for Delivery Service which can be found on our website.
- Before proceeding with the wiring of a new building or the rewiring of an existing building, a service entrance location shall be arranged by calling NHEC Construction Services Department to generate a service order.
- For single phase service, four conductors must be installed from the meter main to the distribution panel, for new construction, service upgrades, renovations and relocations.
- Whether or not a signed application for service is made by the Member and accepted by NHEC, the rendering of the service by NHEC and its use by the Member shall be deemed a contract between the parties and subject to provisions of the Tariff. NHEC reserves the right to reject any application for service made by, or for the benefit of a former Member who is indebted to NHEC for delivery of electric service previously furnished to them.
- NHEC reserves the right to reject any application for service if the amount or nature of the service, or the distance of the premises to be served from an existing suitable line, or the difficulty of access thereto is such that the estimated income from the service applied for is insufficient to yield a reasonable return to NHEC, unless such application is accompanied by cash payment.
- The applicant for service will provide, without expense or cost to NHEC, the necessary permits, consents, or easements for a satisfactory right of way for the erection, maintenance and operation of a line, including the right to cut and trim trees and bushes wherever necessary along private property.

- Access shall be safe and adequately maintained to NHEC owned equipment located on a Member's property. NHEC reserves the right to enter the premises to install, maintain, repair, and disconnect meters, equipment, facilities and for all other proper purposes. If safe and adequate access to the meter/equipment is not available for NHEC employees, we reserve the right to discontinue service upon proper notice.
- All NHEC employees are required to carry means of identification which will be shown upon request.
- Should the use or operation of any equipment by a Member including, but not limited to, electric motors, welders, electronic power supplies or speed controls, adversely affect NHEC's ability to render adequate service to others, NHEC reserves the right to discontinue service until suitable corrections are made by the Member.
- For the cost to relocate a meter please reference Schedule of Fees, Charges and Rates located on NHEC's website.
- Meter sockets may be temporarily removed (floated) from buildings by NHEC personnel at the Member's request for siding and cosmetic repairs. This is to be considered temporary in nature and provisions for re-attachment must be made by the Member within one year. Please reference Schedule of Fees, Charges and Rates, under Modifications of Existing Services located on NHEC website.
- NHEC meters, poles, anchors, vaults and other equipment are to be within 15 feet of a traveled way or driveway, considered to be truck accessible year-round.
- Subdivisions/Developments require a unique design, please contact NHEC for assistance.
- Available Service Voltages:

PHASE	WIRES	NOMINAL VOLTAGE
Single	3	120/240
Three	4	120/208
Three	4	277/480

ATTENTION ELECTRICIANS!

Don't pull that meter until you've notified us...

Electricians: you must contact New Hampshire Electric Co-op BEFORE breaking the seal to remove any electric meter that is served by NHEC.

This is especially important as NHEC transitions to an automated outage reporting system. The new digital electric meters installed by NHEC will automatically report an outage when the meter loses power. If we don't know you're removing a meter, we may assume there's an outage at that location or that the meter is being tampered with and dispatch a crew to make repairs. That may result in the member being billed.

According to NHEC's Terms & Conditions, only licensed electricians and trained NHEC employees are allowed to remove an electric meter from its socket.

Before removing an NHEC electric meter, please call 1-800-698-2007 to reach our Member Solutions Department during regular business hours, or our Control Center, which is staffed 24/7/365.

New Service and Re-Clearing Cutting Specifications: NHEC uses an Integrated Vegetation Management Program (IVMP) to maintain our Right of Way corridors. An IVMP consists of Mechanical, Chemical and Cultural control measures. Chainsaws, mechanical mowers, bucket trucks, brush chippers and skidder buckets are the primary machines in our Mechanical Control efforts. These machines clear the brush and hazardous trees from the Right of Way corridor and are the first steps in our IVMP. To learn more about our IVMP visit www.nhec.com/vegetation.

New Service/Construction: Specifications are 15 ft. each side of the PRIMARY line from the ground to a minimum of 20 ft. overhead clearance from the highest conductor on the pole and 10' on secondary line. Reference SP-1 on page 18.

Cycle Re-Clearing: Our goal is to have a maintenance cycle of every 8 years for our service area. Our contractors work year-round on our system. Specifications are 15 ft. each side of the PRIMARY line from the ground to a minimum of 20 ft. overhead clearance from the highest conductor on the pole. This includes all unacceptable vegetation within the corridor. Some right of way widths may be wider depending on the voltages of the line.

Service Lines: The service lines are the electric wires that run from the utility pole to a home or business. While performing our re-clearing NHEC tree contractors will evaluate your service line. If there is apparent wear or hard contact deflecting on the service line causing mechanical strain it will be minimally trimmed. Tree removals on service lines are at the discretion of the Certified Arborist; typically, we do not take them down. It is the homeowner's responsibility to maintain the service wire by keeping it clear of trees in between this cycle. If you are in-between our vegetation management cutting cycle and are going to perform tree work, NHEC will temporarily shut off power, for a fee, so that you can perform the tree work safely and will restore the power once the tree work is finished.

SAFETY NOTE: Stay at least 10 feet away from these energized lines and do not attempt to cut trees or branches around them that are in direct contact with the lines. Hire a qualified contractor to do this work at your expense.

What is a Right of Way: A right of way is a corridor of land owned by a Member or abutter that contains a power line, or power line infrastructure that NHEC has the legal obligation to keep clear of brush/trees. NHEC has easements that allow us to legally cut vegetation within the right of way. When rights-of-way are kept clear, they also provide safe access for our line crews to maintain, repair, or improve the lines and poles.

Storms/Outages: Trees, tree branches and debris are not removed during or after storm; removal is the responsibility of the landowner.

Please visit our website to review our entire program and learn about planting the Right Tree, Right Place at www.nhec.com/vegetation.

Section 2: Metering

GENERAL

A Load Data Sheet is required for all three phase services and any single-phase service greater than or equal to 400 amps.

NHEC may refuse to connect a service or install a meter on any metering installation that does not conform to NHEC's "Requirements for Electric Service Connections".

Meter sockets will be provided, installed and maintained by the Member.

All equipment (including the meter socket) beyond the point of delivery is the responsibility of the Member for installation and maintenance.

Meters will be furnished, owned, and maintained by NHEC and shall be installed, removed, and changed only by authorized NHEC employees.

NHEC does not allow Master Metering; See NHEC Terms & Conditions.

REMOVING AND INSTALLING METERS

Only qualified personnel authorized by NHEC (Meter and/or Operations department), are permitted to cut seals, and remove or install meters. Under emergency conditions, exceptions may be granted to qualified electricians by contacting NHEC. When this occurs, the party accepts all liability for damage or alteration to equipment, injury to persons or property, and loss of revenue to NHEC from the time the seal is removed until 72 hours after NHEC has been notified that the equipment is ready to be re-sealed. The Member or electrical contractor must promptly notify NHEC when repairs or modifications have been completed.

Extreme caution must be used when meters are removed or installed. Depending upon the type of service or meter base, removal of the meter might not de-energize the service.

METER LOCATION

The Member must install the meter socket where it will be accessible to NHEC personnel. Meter socket locations require prior approval by a representative of NHEC. The Member must provide a location to install metering equipment. The meter location must be free from obstruction, corrosive atmosphere, abnormal temperature, vibration, and be convenient to NHEC distribution system. All meters, meter equipment, and enclosures must be readily accessible by NHEC's personnel during normal business hours for meter reading, maintenance, testing, installation, or removal.

The acceptable locations for meter socket are:

- Located outside, except for a pre-approved electrical room
- Located on the front one-third of the house closest to normal public access and/or NHEC's service point
- Located on the driveway gable side
- Located in an area that is not subject to being fenced
- Located on a structure that is owned by the Member

The unacceptable locations for meter socket are:

- Above the first story level or below the first basement level of a building. Any exceptions to this rule must have the approval of NHEC's Meter Department before electrical installation begins
- On poles not owned by NHEC
- On any line pole occupied solely by the telephone company, except to serve telephone

company equipment

- In commercial occupancies they do not serve
- Any place where safety may be compromised
- Located under an eave with less than a 12-inch overhang, meter will require a shelter over it to prevent ice damage
- On pad mount transformers
- On a porch (open or enclosed)

The reasons for these requirements are:

- If there is a fire or other disaster, NHEC can disconnect service
- So NHEC can read the meters in a safe, cost-effective manner
- So NHEC can efficiently maintain the meter
- So NHEC employees can stay out of the Member's backyard

METER SOCKET REQUIREMENTS:

- Require NHEC approval (see approved listing at [Request Service | New Hampshire Electric Co-op](#))
- Meter socket must have an integral main breaker for services of 400 amp or less
- Any Commercial or three-phase installations, 400 amps or less, require a meter socket with an integral main breaker and a lever by-pass.
- Be rated for exterior use, and be rain tight according to NEMA-3R
- Be UL (Underwriters Laboratory) approved for application
- Includes solar production and EV metering equipment
- Have all unused openings tightly sealed from the inside of the socket
- Be plumb and securely fastened to the supporting structure
- Mounting materials shall be weather-resistant as appropriate for the meter socket location
- The meter socket may be ring or ringless type
- Meter sockets shall not be altered or bypassed to provide power.
- Any meter socket containing energized equipment must be covered and sealed with a transparent cover plate when a meter is not installed.
- Terminals must be clearly marked with a Manufacturers listing and labeling for the intended use.
- Multi-tenant occupancies with common area loads require a "house" meter to serve such loads. (See specification SP-5 on page 17.)
- Multi-tenant occupancies are required to have individual meters per section N of our Terms and Conditions.

METER SOCKET LABELING

Each position in multiple meter sockets shall be permanently labeled by the installation electrician to indicate the section or unit they serve. The occupant's name is not acceptable. The unit's 911 address shall be used. The label shall be placed directly adjacent to the service switch or circuit breaker for the identified unit. Labels shall not be mounted on removable covers. The labels must be engraved phenolic plates that are fade resistant and at least one inch high. Handwritten or label maker tape are not considered permanent markings. Service will not be established until marking is complete and verified for accuracy. Meter socket to unit accuracy will be verified, on-site, by NHEC personnel and the installation electrician. (See specification SP-5 on page 17.)

FACTORY BUILT MULTIPLE METER PANEL

Prior to shipment from the factory, the manufacturer, distributor or electrician must submit commercial multiple meter panel drawings to the NHEC Meter Department for approval.

SERVICE CONDUCTORS

Metered circuits must not enter raceways or enclosures containing unmetered circuits, except for meter loops on poles, or in specific situations approved by NHEC Meter Department. Enclosures and raceways that contain unmetered conductors must have provisions for sealing or locking by NHEC.

MEMBER LOAD MONITORING

The Member's load monitoring equipment must be installed only on the load side of the meter. No Member equipment is allowed inside a meter or current transformer enclosure.

CLEARANCE REQUIREMENTS

- The Member must provide and maintain the following clearances around all meter installations.
- The center of the meter must be between 5 and 5 1/2 feet above finished grade.
- A working space of 3 feet wide by 3 feet deep is required around the meter. This working space is to be kept clear of any obstructions including landscaping.
- Metering equipment must remain accessible, at all times.
- For propane device or equipment clearances, please see SP-4, located on page 16.
- Must meet the National Electrical Code clearance requirements.

ELECTRICAL ROOMS

Meter sockets may be located inside an electrical equipment room. The electrical room must be used solely for power and communication equipment. The electrical room must be well lit, accessible during normal business hours, and not used for storage. The Member is responsible for providing a location near the door for installation of a key box, a key for the box, and for installing a sign on the exterior door saying "Electrical Room."

GROUNDING

All meter sockets, CT cabinets, enclosures, and conduit must be bonded and grounded in accordance with the latest edition of the NEC and in accordance with the NHEC requirements detailed in the construction standards contained in this handbook. A suitable means must be provided by the Member for attachment of other utilities to the Member's grounding electrode system.

FIRE PUMPS

All fire pump installations require CT rated metering (See services greater than 400 amps).

SERVICES 400 AMPS OR LESS

SERVICE CONDUCTORS FOR SELF-CONTAINED METERING

Line-side conductors must always be connected to the top terminals of the meter socket. Service conductors must be arranged in the socket to avoid interfering with the meter installation or operation of the bypass. The member is responsible for ensuring that the connection of service entrance conductors in the meter socket are inspected and tightened before the service is energized. Meters will not be installed if conductors place undue strain on the terminal facilities. Terminals must be rated for the size of the conductor to be used.

Strands must not be removed to make conductors fit under-sized terminals.

SEQUENCE OF EQUIPMENT

All service equipment must be metered ahead of the disconnect switch. Under special conditions, permission may be granted to modify this sequence in multiple meter installations of more than six meters, provided that all equipment ahead of the meters is capable of being sealed by NHEC.

BASIC SINGLE-PHASE SERVICE

The 120/240 volt, 200 ampere service is the most common service, and is typically installed on homes and some small businesses. However, it is the Member's responsibility to determine electrical requirements and to notify NHEC of the service size needed.

SINGLE-PHASE 120/208 VOLT SERVICES

A five terminal meter socket is required on all single-phase networked 120/208 volt service. The fifth terminal must be in the nine o'clock position, connected to the socket neutral bus conductor.

THREE-PHASE

Three-phase service requires a seven terminal meter socket, the neutral (grounded) conductor must be connected to the third terminal from the left on the lower terminals.

SERVICES GREATER THAN 400 AMP

Provisions for current transformers must be made when the current-carrying capacity of the **service entrance conductors** or renewable energy source exceeds 400 amps single phase or three phase, as determined by NHEC. **The Member is responsible for the following:**

- **Member must supply load data survey sheet to the Meter Department for proper sizing of CT's.**
- Provide and install a current transformer (CT) enclosure where designated by NHEC.
- The Member must install the CT enclosure on the supply side of the main disconnect, unless otherwise approved by NHEC's Meter Department.
- All CT enclosures require a minimum front clearance of 36 inches. Hinged CT enclosure doors must not block a safe exit, the meter or the meter socket while open. (Refer to SP-4 on page 16.)
- The top of the CT enclosure is a maximum of 8 feet above finished grade; the bottom is a minimum of 2 feet above the finished grade.
- CT enclosure located on exterior of building preferred. Remote locations require two 6"x6" minimum square posts set 5' below finished grade.
- CT cabinets shall be bonded, by the electrician, with a properly sized conductor either solid or stranded. The CT cabinet bond shall not rely on metal to metal contact of enclosures or raceways.
- All Member-supplied CT mounting equipment shall be listed and labeled and shall be installed and used in accordance with any instructions included with that equipment.
- CT cabinet shall be mounted within 25' conduit length of the meter socket.
- CT cabinet and meter socket shall be mounted on the building wall, a back board or suitable

pedestal.

- **NHEC may require a main breaker after the CT cabinet.**

SERVICE EQUIPMENT

The Member is responsible for furnishing, installing, and maintaining all required service entrance equipment, including the service conductors to the point of delivery designated by NHEC. For services where current transformers (CTs) are required, the Member must also run conduit from the CT enclosure to the meter base. NHEC supplies the CTs and meter wiring.

EQUIPMENT

Current transformer (CT) enclosures, switch gear, gutters that contain unmetered conductors, and metering equipment must have provisions for sealing. Contact NHEC's Meter Department to obtain access for inspection.

NHEC will furnish, install, and maintain the following equipment:

- Revenue meters
- Current transformers
- CT meter wiring

The Member is responsible for furnishing, installing, and maintaining the following equipment beyond the point of delivery:

- Approved meter sockets, see approved list for Meter Socket and CT enclosures on the NHEC website or call and one will be provided
- All necessary wiring, connectors, and lugs (except CT meter wiring)
- Current transformer cabinet upon NHEC's approval
- Switches
- Conduit

CT METERING CIRCUIT CONDUIT

NHEC requires 1 ¼ inch conduit between the meter socket and CT enclosure which shall be provided and installed by the Member. Conduit must be as short as possible and cannot exceed 25 feet in length and shall be installed according to NHEC's requirements. A pull-string of 1/4 inch polypropylene rope is required in all meter conduits

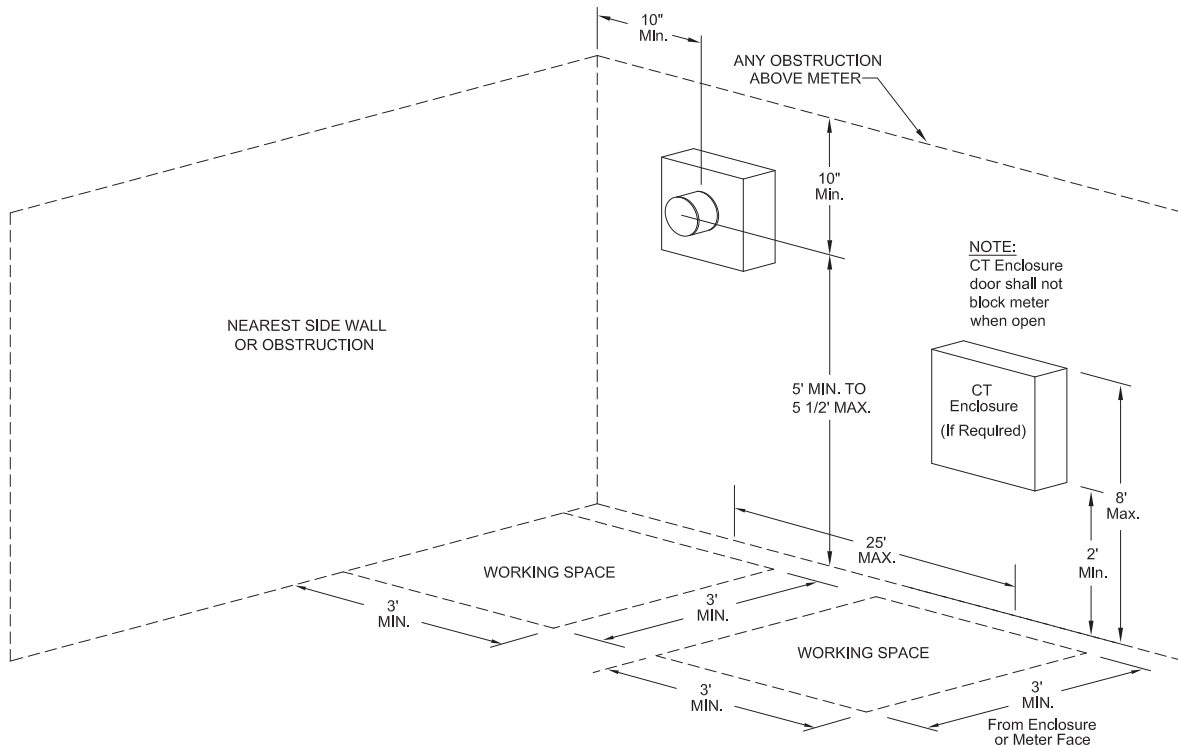

METER SOCKET & CT ENCLOSURE MINIMUM CLEARANCES

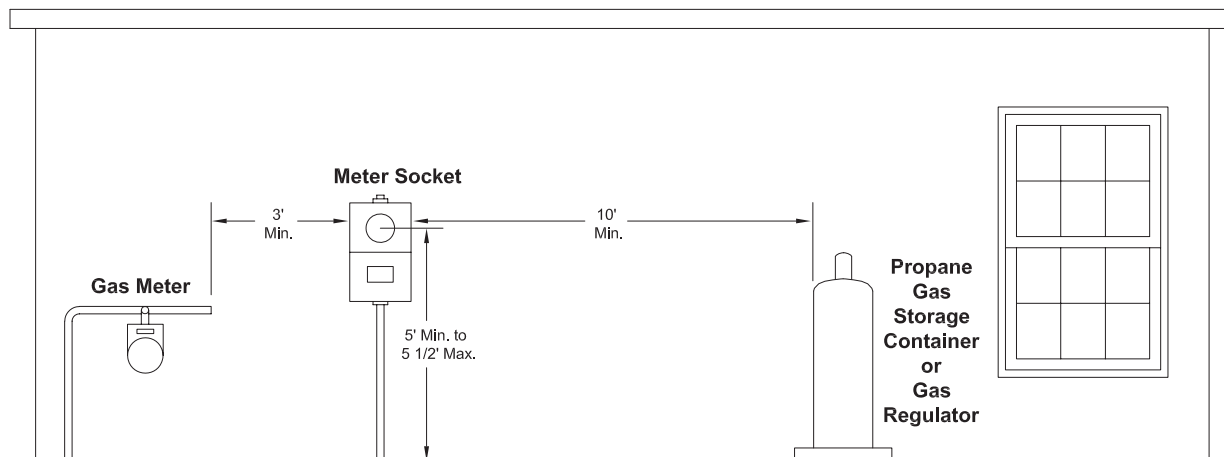

METER SOCKET CLEARANCES TO GAS METER, STORAGE CONTAINER OR GAS REGULATOR

UP TO SIX GANG METERS
WITH NO MAIN DISC.
AHEAD OF METERS

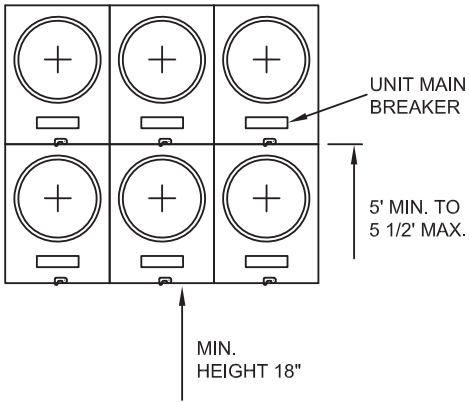

MORE THAN SIX GANG METERS WITH MAIN DISC. AHEAD OF METERS

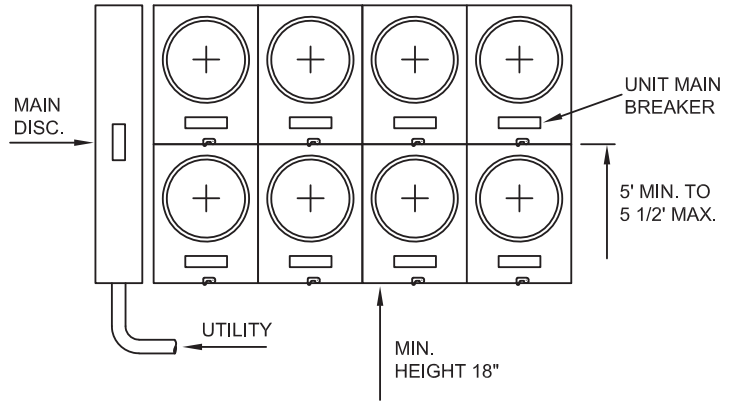

UP TO SIX GANG METERS
WITH NO MAIN DISC.
AHEAD OF METERS

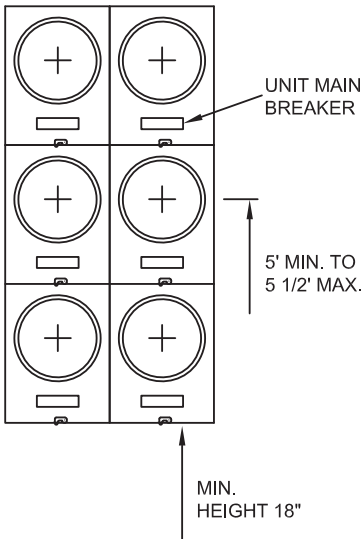

MORE THAN SIX GANG METERS WITH MAIN DISC. AHEAD OF METERS

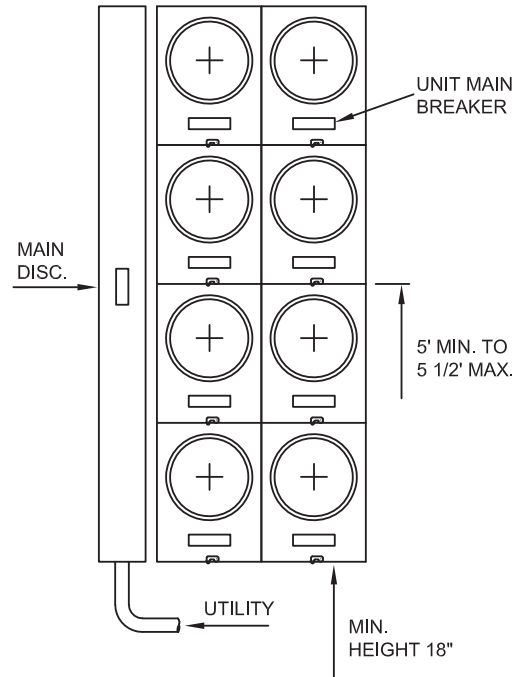

NOTES:

- 1.) ALL UNITS REQUIRE A MAIN BREAKER WHETHER OR NOT THERE IS A MAIN DISCONNECT AHEAD OF THE METERS.
- 2.) ALL SOCKETS MUST BE LABELLED WITH THE NUMBER OF THE UNIT SERVED.
- 3.) REFER TO METERING SECTION FOR INFORMATION ABOUT SOCKET LABELLING, FACTORY BUILT MULTIPLE METERS PANELS AND SEQUENCE OF EQUIPMENT.

NO VEGETATION OVERHANG

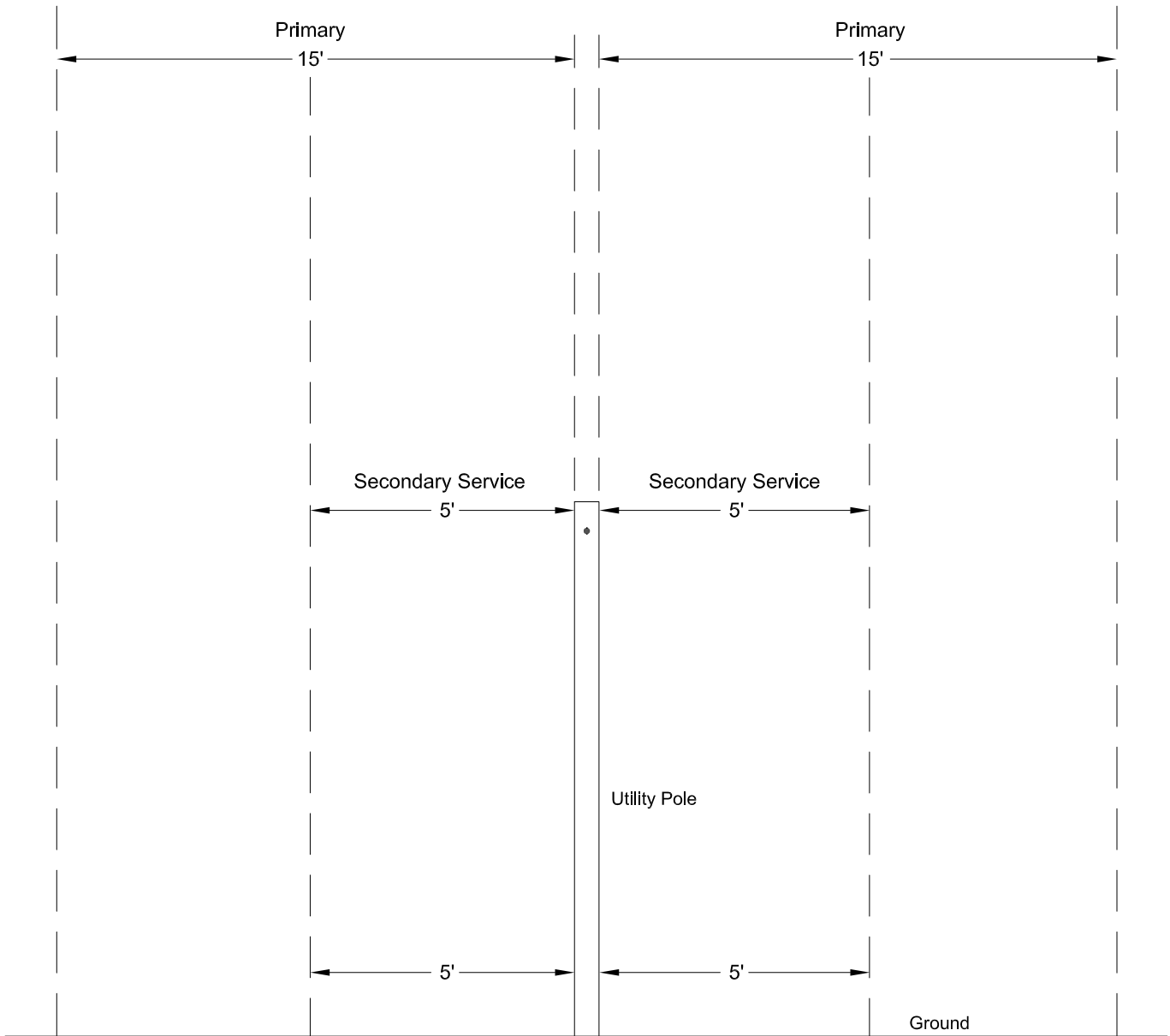

NOTES:

1.) The above drawing references our specification for new service clearing or existing modifications for construction re-clearing. For maintenance re-clearing our specification is 15' either side of the primary line from ground to a minimum of 20ft. overhead clearance, this includes all unacceptable vegetation within the corridor. The service lines are the electric wires that run from the utility pole to a home or business. While performing our re-clearing NHEC tree contractors will evaluate your service line. If there is apparent wear or hard contact deflecting on the service line causing mechanical strain it will be minimally trimmed. For more details on our Vegetation Management Program please visit NHEC's website www.nhec.com/vegetation.



SPECIFICATIONS

NEW SERVICE OR CONSTRUCTION RE-CLEARING SPECIFICATION

SP-1

ISSUE DATE: 06/21

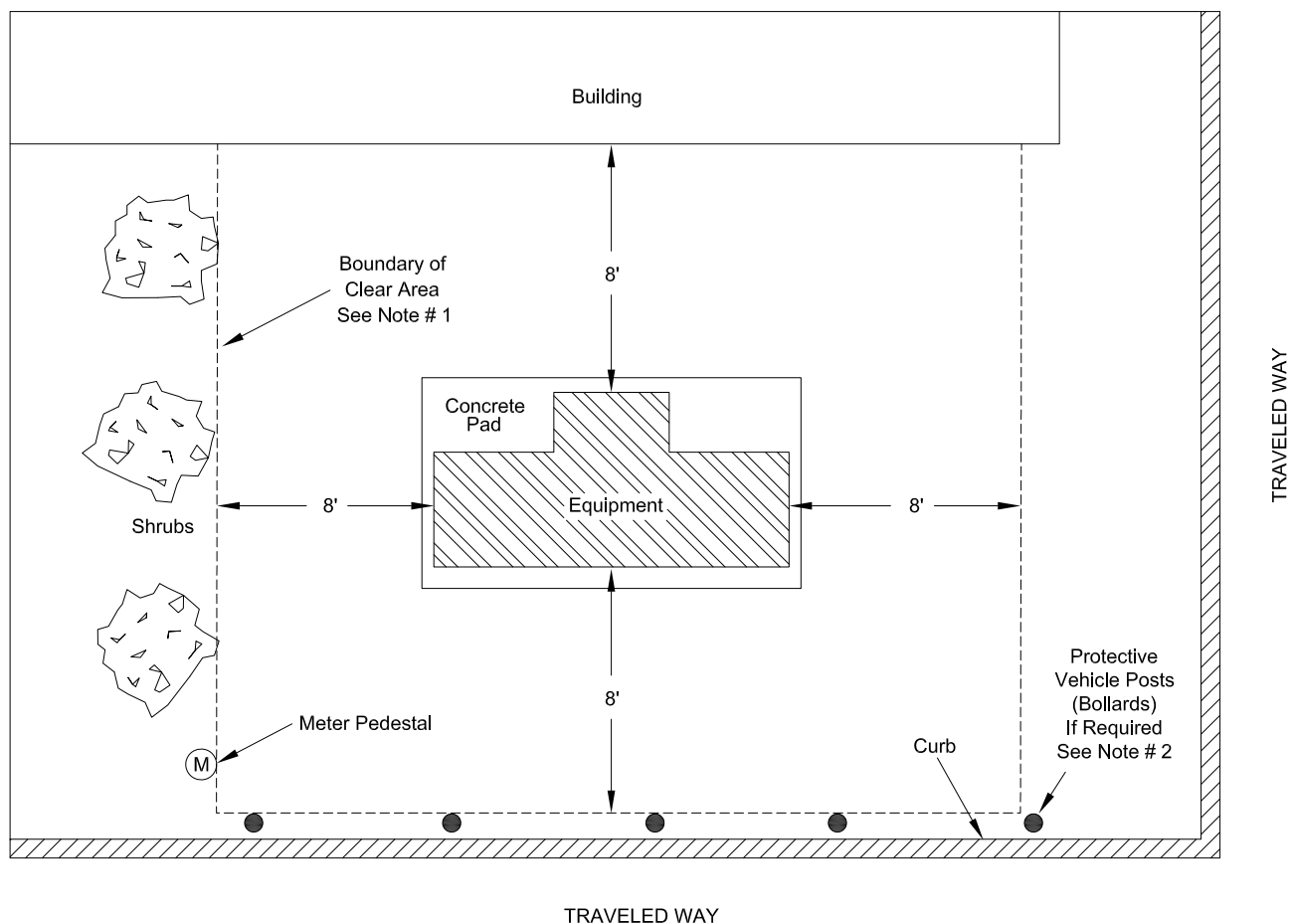

MINIMUM CLEARANCES TO PADMOUNT TRANSFORMER EQUIPMENT

Non-Combustable Walls	8'	Bollards, Meters, Sprinkler Valves, Standpipe or Hydrant	8'
Combustable Walls, Doors, Windows, Vents, Other Openings, Fire escapes	10'	Above Grade Fuel Tanks/Meters	10'
Driveways, Parking Lots, and/or Traveled Ways	10'	Natural Gas or Propane Connections/Meters	15'
Sidewalks	8'	Gasoline Dispensing Units	20'
Property Lines (from sides of equipment)	8'	Facilities used to dispense or store hazardous liquids or gases; (example, service station gas pumps and tanks, propane bulk dispensing tanks and emergency generator fueling points.)	20'
Property Lines (from doors of equipment)	10'		
Shrubs	8'	Electrical Padmount Equipment	8'
Pools	15'		

NOTES:

- 1.) To inspect, provide access, operate and ventilate the equipment, the above specified clear area distances to buildings or shrubs shall be maintained. All distances shall be measured from the nearest surface of the equipment. Property lines shall be considered an obstruction, since fences, shrubs, etc. may be installed at a future date by adjacent property owners.
- 2.) If no curb exists, or transformer is located closer than 10' to the traveled way, protective vehicle posts (●) shall be installed.
- 3.) Top of transformer pad shall be installed 6" above finished grade.
- 4.) Transformer shall not be located on steep grades where access is made difficult.
- 5.) Transformer is NOT to be located with its doors facing the building.



SPECIFICATIONS

CLEARANCES FOR PADMOUNT EQUIPMENT

SP-2

ISSUE DATE: 11/2016

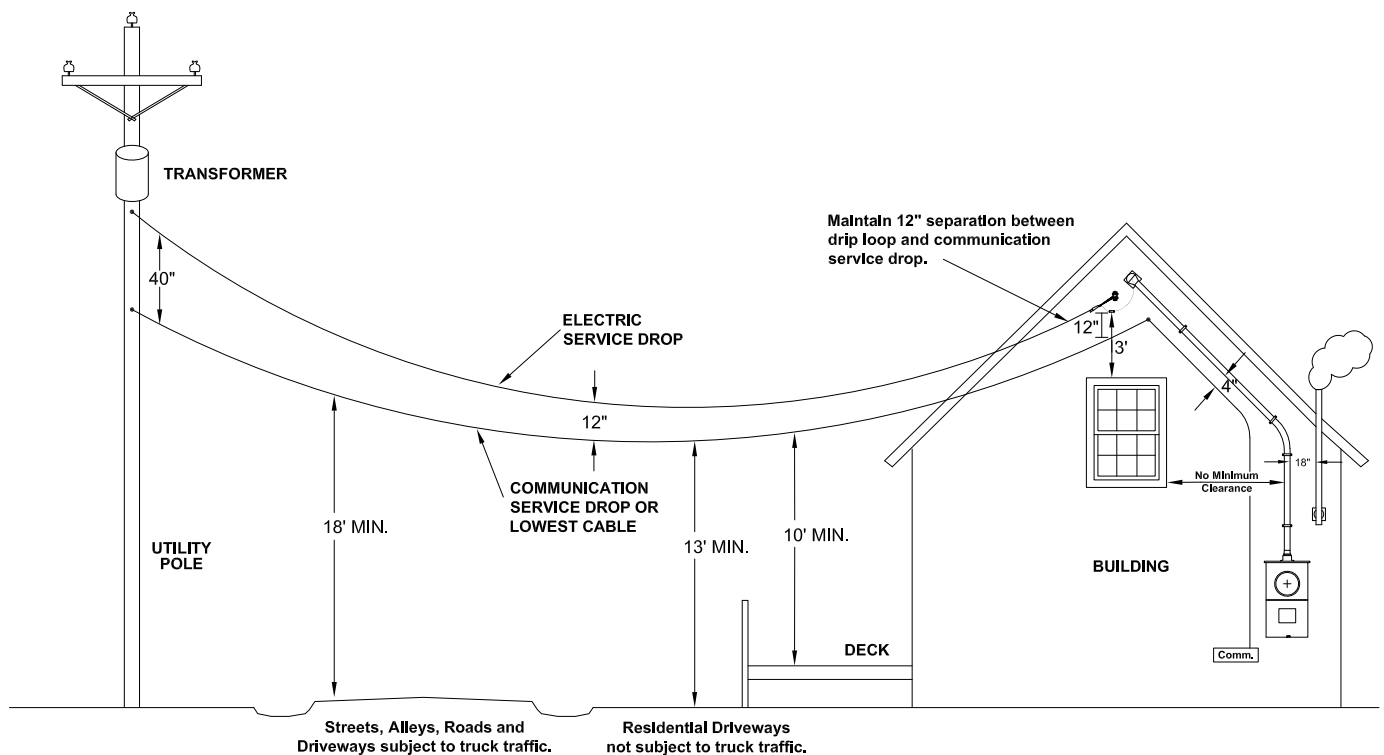

NOTES:

1. Separation from Electric Service Drop (TPLX) and Communication Service Drop at Pole is 40" NESC 235-5 Table 1(a).
2. Separation from Electric Service Drop (TPLX) and Communication Service Drop at any point in the span including the point of attachment is 12" NESC 235(C)1 and NEC 800.44(A)4.
3. Separation from Service Entrance Conductors and Communication Service Drop running down the side of the building is 4" NEC 800.50(B).
4. Electric Service Drop (TPLX) conductors and connections shall have a clearance of 3' in any direction from windows that are designed to be open, doors, porches, balconies, ladders, stairs, fire escapes and similar locations, except when run above the top level of the window. NESC 234(C)3d2 and NEC 230.9(A)
 Note 4a) There are no minimal clearances for SEU, SER, PVC, EMT, or Rigid Metal Conduit from open portions of windows.
5. Service Weather-Heads shall be located above the Electric Service Drop point of attachment and shall not be farther than 24" NEC 230.54(C).
6. Electric Service Drop Vertical Clearances Above Ground please reference NESC 232-1 Table including Footnotes.
7. Vertical Clearance, from highest point of readily accessible roofs, balconies, porches, or decks over which they pass is 10' NESC 234(C)3d and NEC 230.24(B)1.
 Note 7a) When the roof or balcony is not readily accessible the clearance including the drip loop shall not be less than 3' when Electric Service Drop is owned by the Utility.
 Note 7b) If Electric Service Drop is privately owned the Vertical Clearance above roofs is 8' NEC 230.24(A).
 Note 7c) A roof, balcony, porch, or attached deck is considered readily accessible to pedestrians if it can be casually accessed through a doorway, window, ramp, stairway, or permanently mounted ladder by a person, on foot, who neither exerts extraordinary physical effort nor employs tools or devices to gain entry. A permanently mounted ladder is not considered a means of access if its bottom rung is 8 ft or more from the ground or other permanently installed accessible surface.
8. Trucks are defined as any vehicle exceeding 8 ft in height.
9. Maintain 18" horizontal separation between direct vent exhaust and piping from all NHEC electric service wires and service equipment.



SPECIFICATIONS

SERVICE CLEARANCES

SP-3

ISSUE DATE: 9/2018

Section 3: Overhead Service Installation

BASIC & LARGE BASIC SERVICE

- All entrance wiring must be completed before NHEC extends service drop conductors to the building.
- Only one service of the same characteristics will be run to a single building except as otherwise permitted by the NEC, or local authority having jurisdiction.
- The point of attachment of a service to a Member's building shall not be less than 15 feet, and no more than 20 feet above permanent ground level. The ground shall be reasonably level to permit the use of a ladder by NHEC employees to attach the service. Service attachments shall be so installed as to permit the service connections to be directly reached from a ladder placed securely on the ground, and as to permit the maintenance of the following minimum clearances as per the National Electrical Code. Refer to Specification SP-3, located on page 20.
 - Point of attachment must be located 3 feet from a window.
 - Fifteen feet above finished grade, sidewalks, residential driveways, and commercial areas not subject to truck traffic.
 - Eighteen feet above roads, streets, alleys, residential driveways, cultivated fields, and areas subject to truck traffic.
 - State and Town Roads require 18 feet clearance.
- The maximum length of service drop which NHEC will install is determined by the characteristics of the load to be served and the terrain over which the service drop passes. If necessary to maintain minimum clearances, additional pole(s) will be installed by NHEC on the Members property.
- Where a building is too low to provide minimum clearance, the Member shall install a service mast of suitable height and strength, guyed if deemed necessary. When such a service mast is installed, the Member shall assume full responsibility for the installation, including roof leaks and shall have adequate strength to support the required service drop. Per NEC requirements, only power service drop conductors may be attached to such mast. Refer to Specification SE-4, located on page 25.
- When **temporary service** is required, the installation shall be in accordance with Construction Standard TS 1, located on page 23 (alternative supporting structures may be used as approved by NHEC). The process and costs of obtaining temporary Overhead service varies, depending upon the location of existing facilities. After contacting NHEC and meeting a Line Design Technician in the field, the Member installs the temporary service equipment and structure, has it inspected (when required by the town), and calls NHEC. Service will be connected once the required documentation, prepayments, and permits have been completed. "Temporary" is installed to provide power during the construction phase of a project and is defined as less than one year by the Federal Energy Regulatory Commission. To continue service beyond one year, the service must be converted to a permanent service and meet all pertinent requirements of this handbook.

- For all overhead service entrances, NHEC will furnish and install the service drop to the point of attachment located on the building or other location, and connectors to connect the service drop to the Member's service entrance conductors. The Member shall furnish and install all necessary service entrance equipment beyond the service drop attachment. For a pole mounted entrance, the Member is to furnish materials above meter socket and NHEC will install.
- Where it is considered necessary by NHEC for the proper installation of large capacity overhead services conductors, the Member shall supply a suitable attachment in the building's exterior wall to support the service drop(s).
- For services to semi-permanent mobile homes, the Member shall install the meter socket with integral main breaker on a suitable service entrance structure separated from the mobile home. Refer to Construction Standards USE 4 on page 34.

MATERIALS FURNISHED AND INSTALLED BY MEMBER

- 1 **WEATHER HEAD**
- 2 **SERVICE ENTRANCE CABLE**
TO BE INSTALLED WITH ENDS EXTENDING 3'-0" OUTSIDE OF WEATHER HEAD FOR DRIP LOOP.
- 3 **CABLE CLIPS**
INSTALLED EVERY 36".
- 4 **WATERTIGHT CONNECTOR**
- 5 **METER SOCKET WITH HUB**
SECURELY ATTACHED TO SUPPORTING STRUCTURE.
- 6 **FUSED OUTDOOR DISCONNECT SWITCH OR BREAKER**
RATED AT LEAST 60 AMPS.
MUST BE WEATHERPROOF.
- 7 **GROUND FAULT CIRCUIT INTERRUPTER**
- 8 **WATERPROOF RECEPTACLE**
- 9 **GROUND WIRE**
SEE NOTE #6
- 10 **GROUND ROD CONNECTORS**
- 11 **GROUND RODS**
(2) MIN. 8'-0" x 5/8" DIAMETER COPPER CLAD.
- 12 **SUPPORTING STRUCTURE**
A.) NO LESS THAN 6" x 6".
B.) TALL ENOUGH TO PROVIDE MINIMUM GROUND CLEARANCE.
C.) SET 3" MINIMUM IN THE GROUND.

MATERIALS FURNISHED AND INSTALLED BY NHEC

- METER
SERVICE DROP CONDUCTORS,
WIRE HOLDER & CONNECTORS

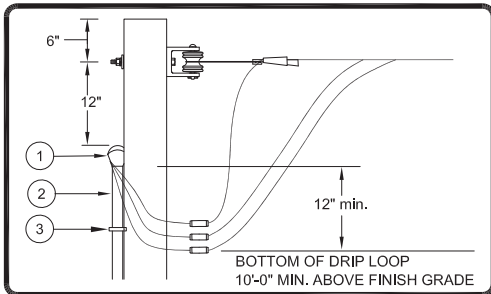
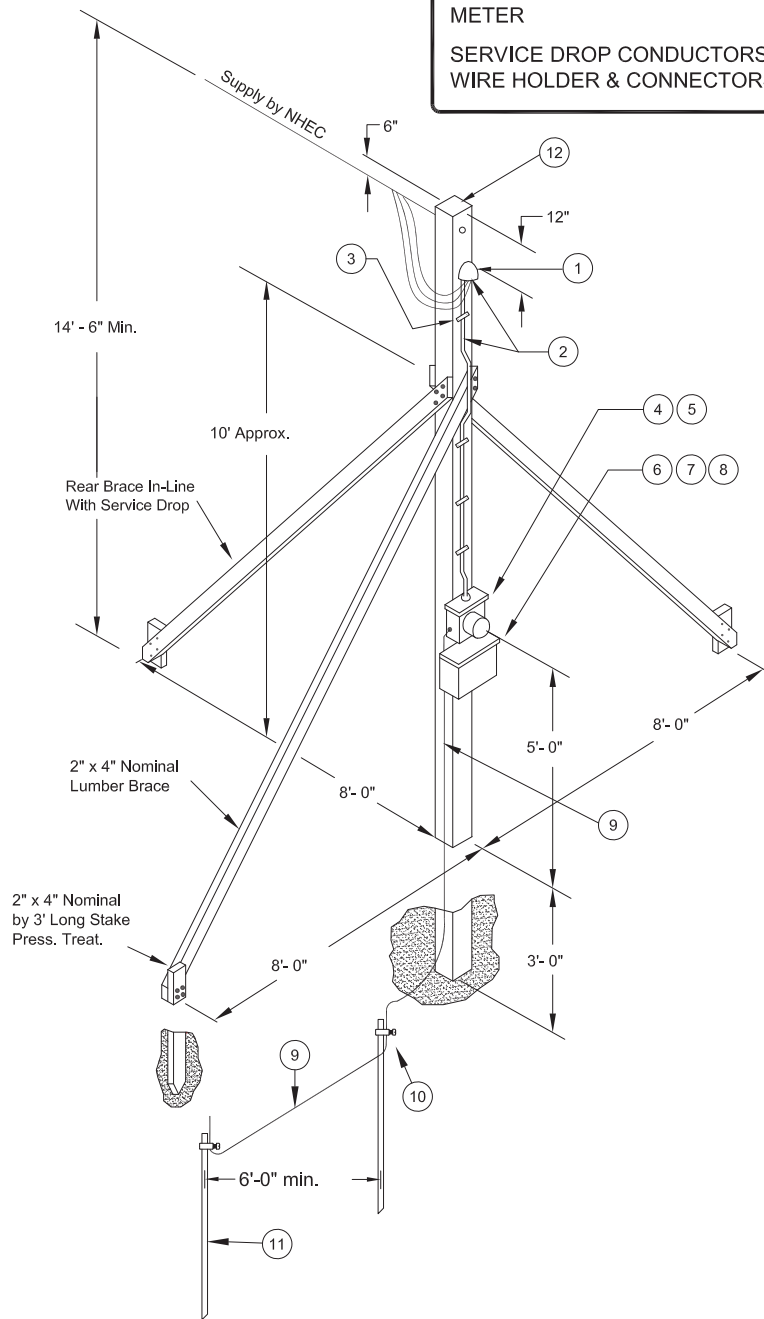

NOTES:

- 1.) Please call NHEC and make arrangements to have the meter location approved before making any changes in your present entrance or installing a new entrance.
- 2.) All wiring and materials must conform to the requirements of the national electrical code and to applicable local codes. Where conflict exists, the more stringent code will apply.
- 3.) Maximum time limit of this service is 12 months.
- 4.) Service structure shall not be further than 75 feet away from last NHEC attachment as arranged with field representative.
- 5.) Alternative supporting arrangements may be used if all clearance and grounding requirements of the NEC are satisfied and the authority having jurisdiction is in agreement.
- 6.) As required by NHEC, No. 6 copper (min. size) bonded to ground rod connectors and two ground rods as illustrated in NHEC construction standards.

MATERIALS FURNISHED AND INSTALLED BY MEMBER

- ① **WEATHER HEAD**
- ② **SERVICE ENTRANCE CABLE**
TO BE INSTALLED WITH ENDS EXTENDING 3'-0" OUTSIDE OF WEATHER HEAD FOR DRIP LOOP.
- ③ **CABLE CLIPS**
INSTALLED EVERY 36".
- ④ **WATERTIGHT CONNECTOR**
- ⑤ **GROUND WIRE**
SEE NOTE #3
- ⑥ **GROUND ROD CONNECTORS**
- ⑦ **GROUND RODS**
(2) MIN. 8'-0" x 5/8" DIAMETER COPPER CLAD.
- ⑧ **METER SOCKET WITH HUB**
SOCKET MUST HAVE INTEGRATED MAIN CIRCUIT BREAKER(S). TO BE SECURELY ATTACHED TO BUILDING BY CONSUMER.

MATERIALS FURNISHED AND INSTALLED BY NHEC

- METER**
- SERVICE DROP CONDUCTORS, WIRE HOLDER & CONNECTORS***
- *NOTE: CONNECTORS FOR SERVICES OVER 500 MCM, WILL BE FURNISHED BY CONSUMER.

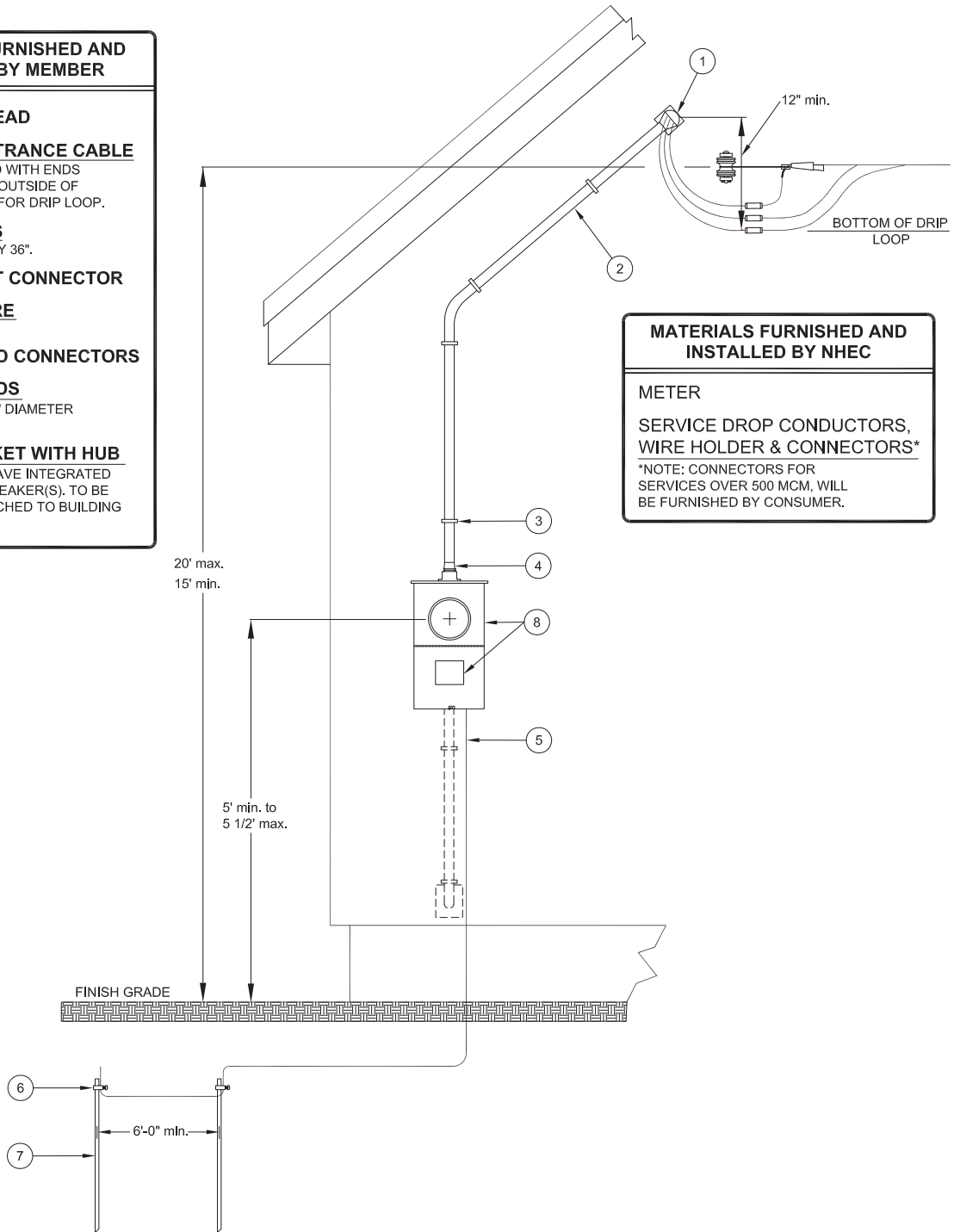

NOTES:

- 1.) Please call NHEC and make arrangements to have the meter location approved before making any changes in your present entrance or installing a new entrance.
- 2.) Four wire cable must be installed from meter socket to distribution panel.
- 3.) As required by NHEC, No. 6 copper (min. size) bonded to ground rod connectors and two ground rods as illustrated in NHEC construction standards.

MATERIALS FURNISHED AND INSTALLED BY MEMBER	
①	WEATHER HEAD
②	INSULATED CONDUIT CLEVIS
③	CONDUIT HANGERS
④	CONDUIT GALVANIZED STEEL
⑤	SERVICE ENTRANCE CONDUCTORS TO BE INSTALLED WITH ENDS EXTENDING 3'-0" OUTSIDE OF WEATHER HEAD FOR DRIP LOOP.
⑥	GROUND WIRE SEE NOTE #7
⑦	GROUND ROD CONNECTORS
⑧	GROUND RODS (2) MIN. 8'-0" x 5/8" DIAMETER COPPER CLAD.
⑨	METER SOCKET WITH HUB SOCKET MUST HAVE INTEGRATED MAIN CIRCUIT BREAKER(S). TO BE SECURELY ATTACHED TO BUILDING BY CONSUMER.
⑩	COUPLING ALL CONDUIT COUPLINGS SHALL BE LOCATED BELOW ROOF EVE.

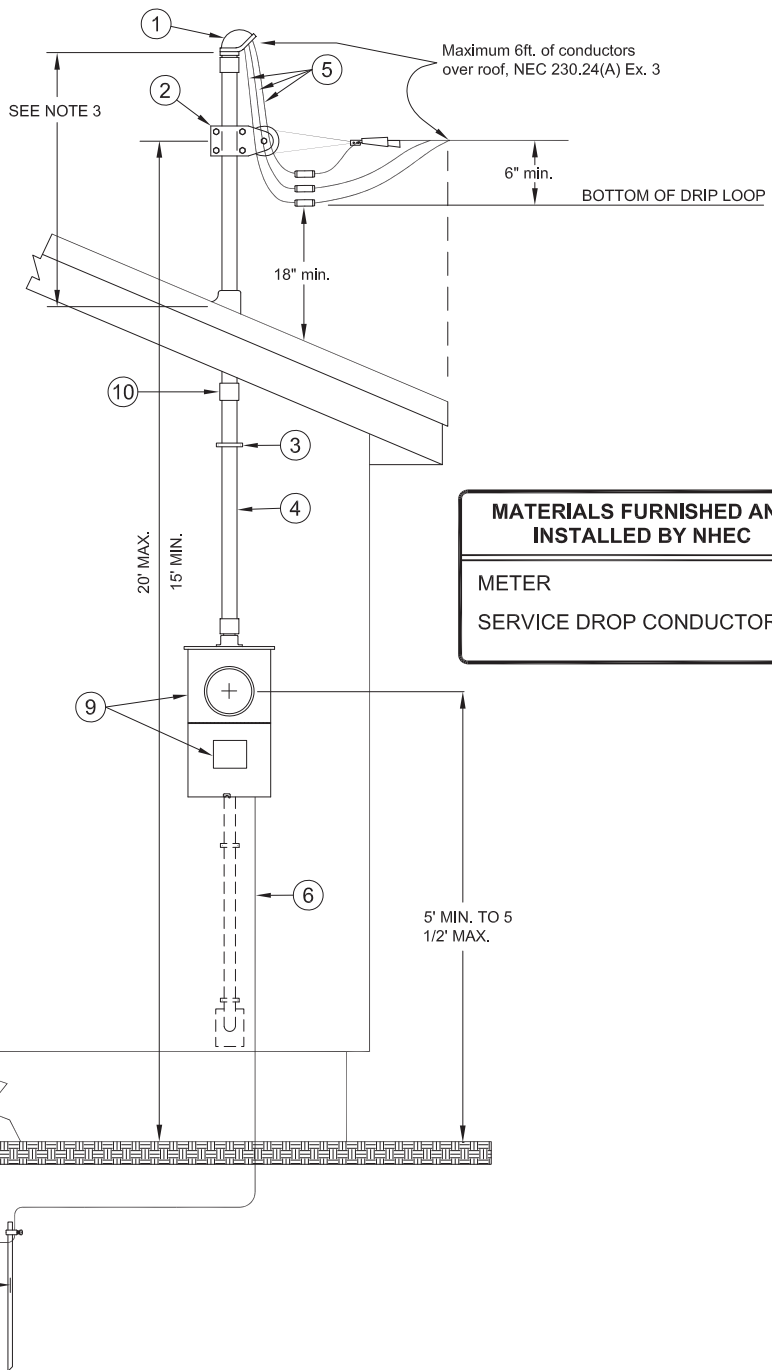

MATERIALS FURNISHED AND INSTALLED BY NHEC	
METER	
SERVICE DROP CONDUCTORS	

NOTES:

- 1.) Please call NHEC and make arrangements to have the meter location approved before making any changes in your present entrance or installing a new entrance.
- 2.) The point of attachment on the building to be determined by the required minimum ground clearances of service drop conductors. Attachment heights in excess of 20 feet are subject to NHEC approval.
- 3.) The member assumes the responsibility that the service mast is of adequate strength. If service mast is greater than 3 feet additional supports, braces or guys will be required.
- 4.) Four wire cable must be installed from meter socket to distribution panel.
- 5.) Only Electric Service Drop conductors shall be permitted to be attached to a Service Mast. NEC 230.28.
- 6.) No more than 6' of conductors pass over no more than 4' of roof. NEC 230.24(A) Ex 3.
Note 6.1) For this rule, conductor length is totaled by Electric Service Drop (TPLX) and Service Entrance Conductors outside of the Service Mast.
- 7.) As required by NHEC, No. 6 copper (min. size) bonded to ground rod connectors and two ground rods as illustrated in NHEC construction standards.



CONSTRUCTION STANDARDS
OVERHEAD SERVICE INSTALLATION
SERVICE MAST
SINGLE RESIDENCE

SE 4

ISSUE DATE: 9/23

Section 4: Underground

GENERAL INSTALLATION REQUIREMENTS FOR UNDERGROUND FACILITIES

- Underground electric service and meter location will be established by NHEC upon site visit.
- In some instances, the type, nature, and/or size of the service requested by a Member may not be available at a desired location.
- When **temporary underground service** is required, the installation shall be in accordance with Construction Standard UTS, located on pages 36 and 37. The process and costs of obtaining temporary underground service varies, depending upon the location of existing facilities. After contacting NHEC and meeting a Line Design Technician in the field, the Member then installs the temporary service equipment and structure, has it inspected (when required by the town), and then calls NHEC. Service will be connected once the required documentation, prepayments, and permits have been completed. “Temporary” is installed to provide power during the construction phase of a project and is defined as less than one year by the Federal Energy Regulatory Commission. To continue service beyond one year, the service must be converted to a permanent service and meet all pertinent requirements of this handbook.
- For conductor requirements:
 - Single phase service 400 amps or less, NHEC provides conductors to the line side of the meter socket.
 - Single phase service 800 amps or less for mulit-gang meter socket requires parallel runs, NHEC provides conductors to the line side of the meter socket.
 - Single phase service greater than 400 amps, Member provides all underground service conductors.
 - Three phase service Member provides all underground service conductors.
- In the case of underground facilities, a Member shall not erect or maintain any building, structure, or any part of the septic system over such facilities and shall not plant any trees or shrubs over such facilities and shall not substantially change the grade over or adjacent to such facilities.
- NHEC vaults and other equipment are to be within 15’ of a traveled way or driveway, considered to be truck accessible year-round.
- Minimum Clearances from equipment see Specification SP-2, located on page 19. The Member must contact NHEC to determine appropriate clearances. These clearances shall not supersede any local ordinance or code which requires greater clearance. If additional fire protection is necessary for insurance and/or other purposes, it is the responsibility of the building/property owner and/or Member to provide additional protection.
- The Member shall furnish at their expense and adhere to NHEC specifications all trenching, backfilling, manholes, conduits, ground wire and vaults necessary for the installation of underground electric distribution facilities.
- Red Caution Ribbon shall be furnished and installed by the Member. This shall be installed the entire length of the trench above the conduit, a foot below finished grade.

- A pulling rope, 1/4 inch diameter polypropylene, shall be installed in each conduit.
- Trenches shall be as straight as possible with no more than 180° of bends which will consist of no more than two 90° sweeps where the run transitions from underground to above ground. Routes through unstable soil such as mud, shifting soils, or other hazards should be avoided.
- Any significant change in the direction of the run shall be accomplished by use of an appropriate pull box.
- Underground facilities shall be a minimum of electrical grade schedule 40 PVC and maintain a minimum depth of 36 inches to finish grade.

EXCEPTIONS:

- Conduits emerging from grade, above grade, under travel ways, roads and driveways, electrical grade schedule 80 PVC shall be used.
- Conduits installed less than 36 inches in depth require NHEC approval after site review and shall be encased in concrete to NHEC's specs.
- Any conduits crossing or within 6 feet of drainage, water, gas, septic or sewer lines, must be encased in concrete. Concrete encasement shall be enclosing the area with 6 inches of concrete, all over, in every direction and 6 feet of concrete either side of the crossing.
- Underground conduit systems shall not be installed within 15 feet of any building foundation, swimming pool, etc., except for where service conduit merges to intercept the service equipment.
- The ends of the conduit shall be plugged during construction to prevent the entrance of foreign matter. The conduit shall be terminated as follows:
 - Conduit shall terminate not more than 3 inches inside a vault. Whenever possible the conduit should run straight into the vault without sweeps or bends. Where the conduit enters the vault, it shall be sealed with hydraulic cement to prevent water, soil and rock intrusion.
- All ends, joints and internal finish of the conduit shall be free of sharp edges or burrs which could damage the cable.
- All conduit joints shall be glued as recommended by the conduit manufacturer. Colored PVC cleaner shall be used before applying glue.
- The Member shall be responsible for having the conduit/vault system ready, prior to NHEC personnel installing the cable. Any additional changes, repairs or other work required to the underground conduit/ vault system in order for NHEC personnel to pull the cable into the conduit shall be the responsibility of the Member.
- Member shall be responsible to cover all open holes or trenches to mitigate any hazardous conditions at the job site prior to NHEC starting their work.

SECONDARY

- Sweeps: Electrical grade schedule 40 PVC 90° sweep(s) with a minimum radius of 36 inches may be suitable in straight runs between riser pole and meter locations less than 200 feet for 3-inch PVC and

150 feet for 4 inch PVC. If runs exceed these limits, then all 90° sweeps must be galvanized steel.

- If a reduction in the service conduit is required, it will occur at the top of the slip joint/expansion fitting utilizing a reducing bushing. The slip joint/expansion fitting will remain the same size as the conduit installed in the trench with the transition occurring above ground. Refer to Construction Standard IU Service Reduction located on page 35.
- Secondary trenches: Required 6 inch minimum spacing between all conduits and trench sidewalls. Refer to Construction Standard IU Secondary Trench, located on page 49.
- Conduits installed in pedestals must be straight up and in close proximity in order to make proper connections.
- At meter locations, the conduit shall terminate as per appropriate meter installation specs. If the meter socket is at a lower grade than the pad mounted equipment location or part of the underground conduit system, provisions shall be made as necessary so that the conduit will not fill with water and run into the meter socket. If a slip coupling (with O-rings removed) is utilized, a six inch deep, one foot wide, and two foot long stone base will be set up under the slip joint for drainage.

PRIMARY

- Sweeps: 4" Electrical grade steel 90° sweep(s) with a minimum radius of 36 inches shall be required where the run transitions from underground to above ground. Sweep shall not be used in the underground portion of the primary run.
- Primary trenches: Require 6 inch minimum spacing between all electric conduits and requires a continuous #6 bare AWG copper grounding conductor that shall be directly buried in the bottom of the trench, prior to installation of any conduit, with a 20-foot coil at each end for connections by NHEC. Refer to Construction Standard IU Primary Trench located on page 48.
- Joint trenches: When electric facilities are installed jointly with communication facilities, clearance between conduits have to maintain 12 inches, the #6 AWG copper bonding conductor, should be readily accessible with adequate length at both ends and shall be installed at each vault and pad mounted equipment location between electric and communication facilities. Refer to Construction Standard IU Primary Trench, located on page 48.
- A drainage system must be installed to daylight in all vaults and sub surface structures. In areas of high-water table, vaults and conduit may need to be elevated to promote effective drainage.
- If the first vault from the riser pole is at a higher grade than the riser location, provisions shall be made as necessary so that the conduit will not fill with water and run up into the riser. Any provision must obtain engineering approval.
- The maximum length between vaults is no more than 600' without Engineering approval.
- Primary splices must be made in vaults.
- All vaults must be parallel with the travel way.

- All primary conduits entering vaults must use the pre-casted knockouts located on the long end of the vault.
- Loop feeds are required when two or more underground transformers are installed. Refer to Construction Standard URD IB, located on page 41.

Underground Checklist

In order to improve our efficiency, we ask that you review the entire Section 4: Underground; page 27 of this handbook in order to ensure a timely and correct underground installation. Please be advised, NHEC can best serve you providing that you give us as much notice in advance as possible. If NHEC specifications are not met, applicable charges, per NHEC's Tariff will apply.

Please call our Construction Services Department at (877) 677-3236 and reference your Work Order # _____

Please be sure that you have completed all applicable steps below:

- Did you contact NHEC for a trench inspection?
- Is your trench the proper depth?
- Did you install the correct conduit meeting NHEC minimal requirement?
- Did you use the correct minimal radius 36" sweeps (steel or PVC)?
- Did you use the proper amount of sand in the trench?
- Did you install the Copper Ground Conductor (if applicable)?
- Did you install the correct Caution Ribbon at the right depth?
- Did you install the correct Pulling Rope?
- Is the meter located in the NHEC pre-determined location?



Conduit and Trench Inspection Notice

All Contractors and Developers Requesting Underground Electrical Service shall call the Construction Services Department of New Hampshire Electric Cooperative a minimum of 24 hours before trench is started to make arrangements for on-site inspection by NHEC Construction Personnel. NHEC will conduct an on-site inspection within 2 working days of the inspection request.

All trenches will be left open so that the conduit system can be certified as meeting the "Installation Requirements for Underground Conduit Systems" as listed in the "Handbook for Electric Service" provided by NHEC.

Once certification has been completed, an NHEC "approval" sticker will be placed at the appropriate location on the meter socket to notify all parties that the Underground Electrical System can be installed.

Failure to comply with this requirement will result in the system being re-exposed so that the proper inspection can be performed. No electrical service will be installed until the inspection sticker is in place.

Please be prepared to give all information regarding your project to our Construction Services representative, including your Service Order #

_____.



**CONTACT NUMBER:
1-877-677-3236**

MATERIALS FURNISHED AND INSTALLED BY MEMBER

- ① **3" OR 4" CONDUIT**
CONDUIT MAY BE EITHER SCHEDULE 80 PVC OR GALVANIZED STEEL & INSULATED BUSHING.
- ② **PIPE STRAPS**
- ③ **3" OR 4" SLIP JOINT**
FROST HEAVE PROTECTION
INSTALLED ABOVE GRADE
- ④ **3" OR 4" CONDUIT (IF NEEDED)**
SCHEDULE 40 PVC. BELOW FINISH GRADE.
- ⑤ **3" OR 4" 90°, 36" RADIUS SWEEP**
- ⑥ **3" OR 4" ADAPTER (IF NEEDED)**
- ⑦ **GROUND WIRE**
SEE NOTE #6
- ⑧ **GROUND ROD CONNECTORS**
- ⑨ **GROUND RODS**
(2) MIN. 8'-0" x 5/8" DIAMETER
COPPER CLAD.
- ⑩ **METER SOCKET**
SOCKET MUST HAVE INTEGRATED
MAIN CIRCUIT BREAKER(S), TO BE
SECURELY ATTACHED TO BUILDING
BY CONSUMER.
- ⑪ **RED CAUTION RIBBON**
6" WIDE CAUTION RIBBON. MUST SAY
"ELECTRICAL LINE BURIED BELOW".
- ⑫ **1/4" POLYPROPYLENE STRING**
INSTALLED IN ALL CONDUITS WITH STRING
EXPOSED AND TIED OFF AT ENDS THRU
CAPS AT END OF CONDUIT.

MATERIALS FURNISHED AND INSTALLED BY NHEC

- METER**
- UNDERGROUND SERVICE
LATERAL CONDUCTORS**
FURNISHED AND INSTALLED BY COOPERATIVE
FOR BASIC SERVICE;
FURNISHED BY CONSUMER FOR LARGE
BASIC SERVICE.

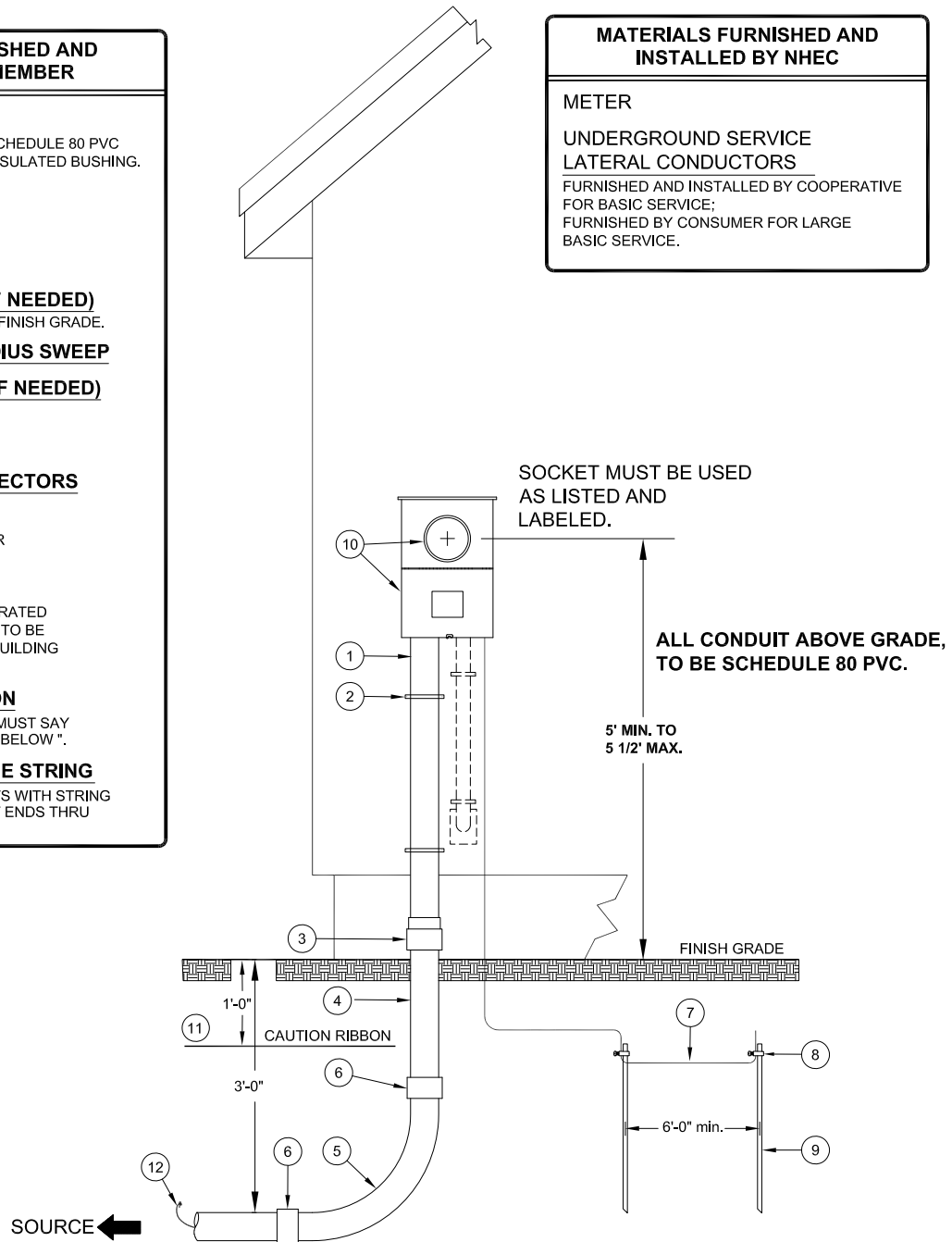

NOTES:

- 1.) Please call NHEC and make arrangements to have the meter location approved before making any changes in your present entrance or installing a new entrance.
- 2.) All service entrance wiring must be complete and all necessary excavation and conduit ready prior to the time of installation of the underground service lateral conductors by NHEC.
- 3.) If a reduction in conduit size is required see IU SERVICE REDUCTION.
- 4.) Four wire cable must be installed from meter socket to distribution panel.
- 5.) Refer to Underground Service Installation Section for further clarification and detailed descriptions for underground installations.
- 6.) As required by NHEC, No. 6 copper (min. size) bonded to ground rod connectors and two ground rods as illustrated in NHEC construction standards.

MATERIALS FURNISHED AND INSTALLED BY MEMBER

- ① **SUPPORT POSTS** (PRESERVATIVE TREATED)
TWO 4" x 4" MINIMUM SQUARE POSTS SET 5' BELOW FINISH GRADE OR ONE 6" x 6" SQUARE POST SET 5' BELOW FINISH GRADE FOR SERVICES OF 100-200 AMPS ONLY.
- ② **MOUNTING BOARD** (PRESERVATIVE TREATED)
2'X3' MINIMUM WITH 1-1/2" THICKNESS
- ③ **PIPE STRAPS**
- ④ **3" OR 4" CONDUIT**
SCHEDULE 80 PVC
- ⑤ **3" OR 4" SLIP JOINT**
FROST HEAVE PROTECTION INSTALLED ABOVE GRADE
- ⑥ **3" OR 4" CONDUIT (AS NEEDED)**
SCHEDULE 80 PVC.
- ⑦ **3" OR 4" 90°, 36" RADIUS SWEEP**
- ⑧ **3" OR 4" ADAPTER (AS NEEDED)**
- ⑨ **GROUND WIRE**
SEE NOTE #6
- ⑩ **GROUND ROD CONNECTORS**
- ⑪ **GROUND RODS (Driven)**
(2) MIN. 8'-0" x 5/8" DIAMETER COPPER CLAD.
- ⑫ **METER SOCKET**
SOCKET MUST HAVE INTEGRATED MAIN CIRCUIT BREAKER(S). TO BE SECURELY ATTACHED TO MOUNTING BOARD BY CONSUMER.
- ⑬ **RED CAUTION RIBBON**
6" WIDE CAUTION RIBBON. MUST SAY "ELECTRICAL LINE BURIED BELOW".
- ⑭ **1/4" POLYPROPYLENE STRING**
INSTALLED IN ALL CONDUITS WITH STRING EXPOSED AND TIED OFF AT ENDS THRU CAPS AT END OF CONDUIT.

MATERIALS FURNISHED AND INSTALLED BY NHEC

- METER**
- UNDERGROUND SERVICE LATERAL CONDUCTORS** (TRANSFORMER TO METER)
FURNISHED AND INSTALLED BY COOPERATIVE FOR BASIC SERVICE;
FURNISHED BY CONSUMER FOR LARGE BASIC SERVICE.

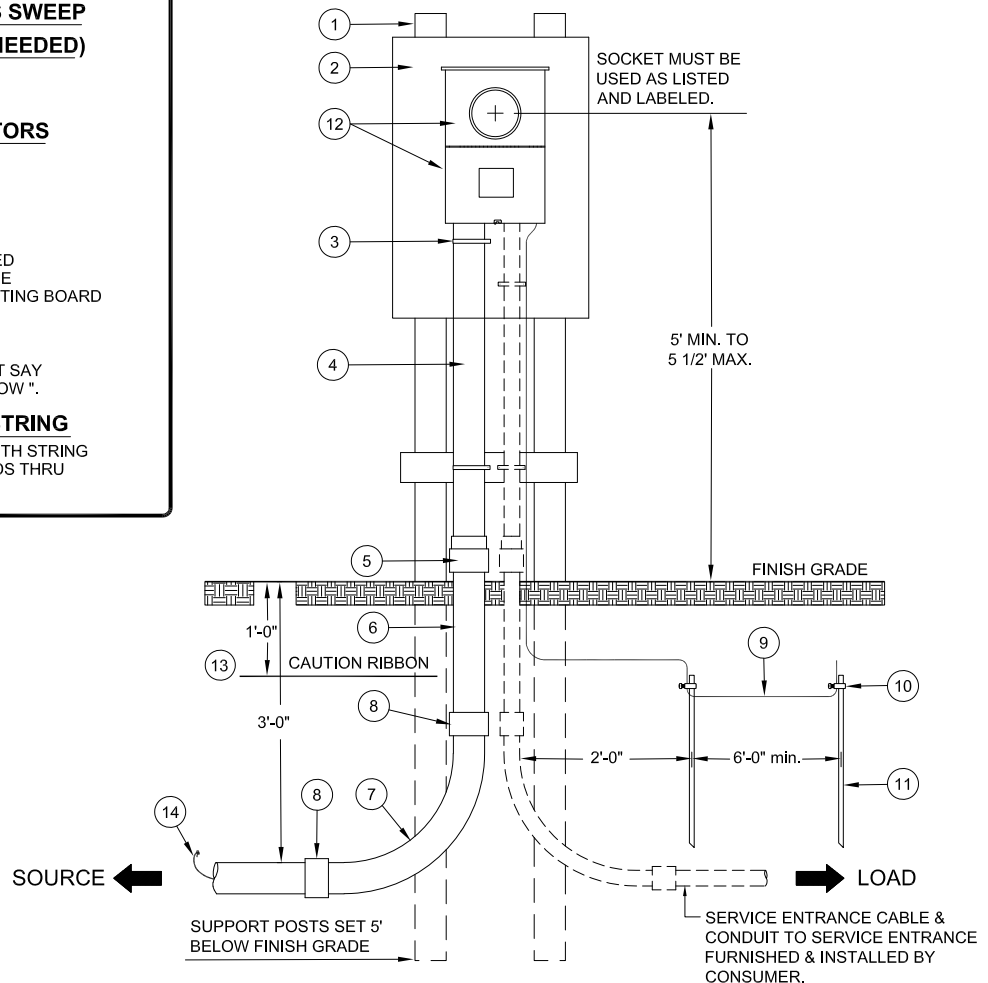

NOTES:

- 1.) Please call NHEC and make arrangements to have the meter location approved before making any changes in your present entrance or installing a new entrance.
- 2.) All service entrance wiring must be complete and all necessary excavation and conduit ready prior to the time of installation of the underground service lateral conductors by NHEC.
- 3.) All service entrance wiring must be complete and all necessary excavation and conduit ready prior to the time of installation of the underground service lateral conductors by NHEC.
- 3.) If a reduction in conduit size is required see IU SERVICE REDUCTION.
- 4.) Four wire cable must be installed from meter socket to distribution panel.
- 5.) Refer to Underground Service Installation Section for further clarification and detailed descriptions for underground installations.
- 6.) As required by NHEC, No. 6 copper (min. size) bonded to ground rod connectors and two ground rods as illustrated in NHEC construction standards.

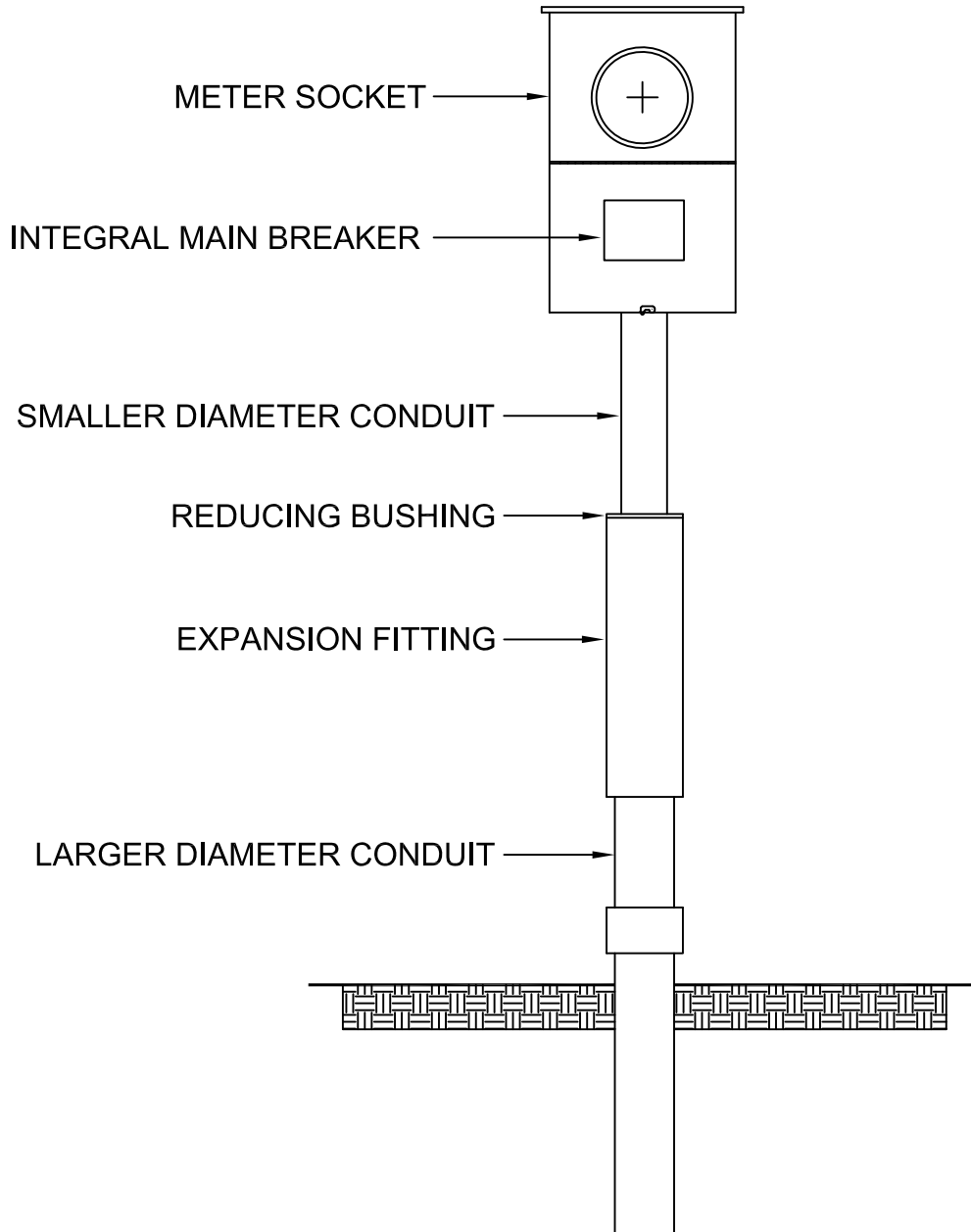

MATERIALS FURNISHED AND INSTALLED BY MEMBER

- ① **SUPPORT POST**
6" x 6" MIN. SQUARE OR 8" DIA. MIN. ROUND.
- ② **METER SOCKET**
NEEDS TO BE SECURELY ATTACHED TO POST.
- ③ **SERVICE ENTRANCE CABLE**
CONNECTION TO TRANSFORMER MADE BY COOPERATIVE.
- ④ **PIPE STRAPS**
- ⑤ **2" CONDUIT**
LIQUIDTIGHT FLEXIBLE NON-METALLIC CONDUIT; TYPE LFNC MAY BE USED FOR THIS INSTALLATION IN LIEU OF SCHEDULE 80 PVC OR GALVANIZED STEEL & INSULATED BUSHING. ATTACH TO TRANSFORMER VIA KNOCKOUT PANEL.
- ⑥ **GROUND WIRE**
SEE NOTE #4.
- ⑦ **GROUND ROD CONNECTORS**
- ⑧ **GROUND RODS**
(2) MIN. 8'-0" x 5/8" DIAMETER COPPER CLAD.

MATERIALS FURNISHED AND INSTALLED BY NHEC

METER

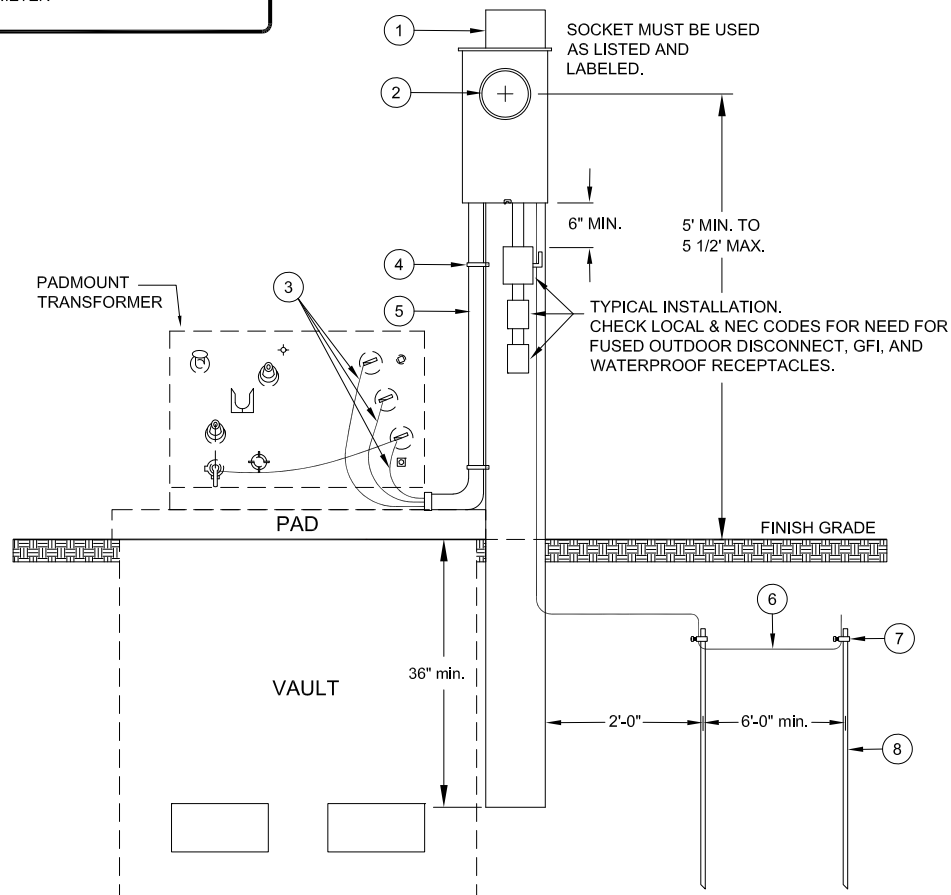

NOTES:

- 1.) Please call NHEC and make arrangements to have the meter location approved before making any changes in your present entrance or installing a new entrance.
- 2.) Maximum time limit of this service is 12 months.
- 3.) Refer to Underground Service Installation Section for further clarification and detailed descriptions for underground installations.
- 4.) As required by NHEC, No. 6 copper (min. size) bonded to ground rod connectors and two ground rods as illustrated in NHEC construction standards. Galvanized steel conduit must be bonded to ground wire, as required.

MATERIALS FURNISHED AND INSTALLED BY MEMBER

- ① **SUPPORT POST**
2" x 8" x 8' OR 10'
OR SECTION OF WALL
 - ② **METER SOCKET**
NEEDS TO BE SECURELY ATTACHED TO POST.
 - ③ **SERVICE ENTRANCE CABLE**
 - ④ **PIPE STRAPS**
 - ⑤ **3" OR 4" CONDUIT**
 - ⑥ **GROUND WIRE**
SEE NOTE #10.
 - ⑦ **GROUND ROD CONNECTORS**
 - ⑧ **GROUND RODS**
(2) MIN. 8'-0" x 5/8" DIAMETER
COPPER CLAD.
 - ⑨ **3" OR 4" SLIP-JOINT**
FROST HEAVE PROTECTION
 - ⑩ **3" OR 4" CONDUIT (IF NEEDED)**
SCHEDULE 80 PVC.
 - ⑪ **3" OR 4" ADAPTER (IF NEEDED)**
 - ⑫ **3" OR 4" 90°, 36" RADIUS SWEEP**
(SEE NOTE 6)
 - ⑬ **CAUTION RIBBON**
RED, 6" WIDE CAUTION RIBBON. MUST SAY
" ELECTRICAL LINE BURIED BELOW "
 - ⑭ **1/4" POLYPROPYLENE STRING**
INSTALLED IN ALL CONDUITS WITH STRING
EXPOSED AND TIED OFF AT ENDS THRU
CAPS AT END OF CONDUIT.
- UNDERGROUND SERVICE LATERAL CONDUCTORS**
TO BE INSTALLED BY COOPERATIVE.

MATERIALS FURNISHED AND INSTALLED BY NHEC

- METER**
- UNDERGROUND SERVICE LATERAL CONDUCTORS**
FURNISHED AND INSTALLED BY COOPERATIVE FOR BASIC SERVICE.
FURNISHED BY CONSUMER FOR LARGE BASIC SERVICE.

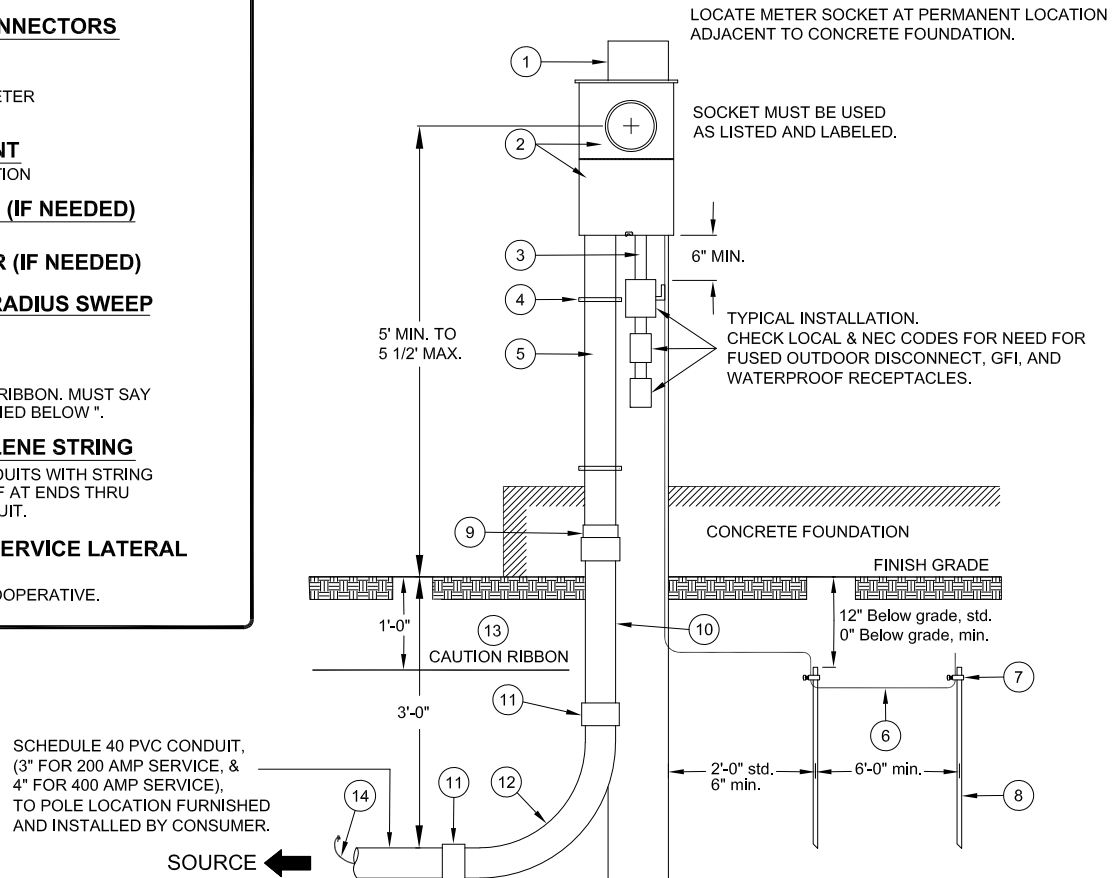

NOTES:

- 1.) Please call NHEC and make arrangements to have the meter location approved before making any changes in your present entrance or installing a new entrance.
- 2.) All conduit and accessories must meet electrical grade specifications.
- 3.) All service entrance wiring must be complete and all necessary excavation and conduit ready prior to the time of installation of the underground service lateral conductors by NHEC.
- 4.) All wiring and materials must conform to the requirements of the national electrical code and to applicable local codes. Where conflict exists, the more stringent code will apply.
- 5.) The member is responsible for all trenching. Refer to cooperative distribution standards for trenching specifications.
- 6.) An electrical grade schedule 40 PVC 90° sweep with a minimum radius of 36 inches may be substituted in straight runs between riser pole and meter for 500 U.S.E. less than 150 feet, for 4/0 U.S.E. less than 200 feet, and 1/0 U.S.E. less than 200 feet in length. If runs exceed these limits, then ALL 90° sweeps must be galvanized steel and bonded.
- 7.) Maximum time limit of this service is 12 months.
- 8.) Four wire cable must be installed from meter socket to distribution panel.
- 9.) Refer to Underground Service Installation Section for further clarification and detailed descriptions for underground installations.
- 10.) As required by NHEC, No. 6 copper (min. size) bonded to ground rod connectors and two ground rods as illustrated in NHEC construction standards. Galvanized steel conduit must be bonded to ground wire, as required.

INSTALLATION REQUIREMENTS FOR UNDERGROUND SERVICE

UJ3 - 2
UJ3 - 3
UJ3 - 4

MATERIALS FURNISHED AND INSTALLED BY MEMBER

USE 3" CONDUIT FOR 200 AMP SERVICE AND 4" FOR SERVICES GREATER THAN 200 AMPS

- ① **3" OR 4" CONDUIT**
SCHEDULE 80 PVC.
- ② **3" OR 4" 90°, 36" RADIUS SWEEP**
(SEE NOTE 5)
- ③ **3" OR 4" ADAPTER**
(IF NEEDED)
- ④ **3" OR 4" CONDUIT**
SCHEDULE 40 PVC
- ⑤ **RED CAUTION RIBBON**
6" WIDE CAUTION RIBBON, MUST SAY "ELECTRICAL LINE BURIED BELOW".
- ⑥ **1/4" POLYPROPYLENE STRING**
INSTALLED IN ALL CONDUITS WITH STRING EXPOSED AND TIED OFF AT ENDS THRU CAPS AT END OF CONDUIT.

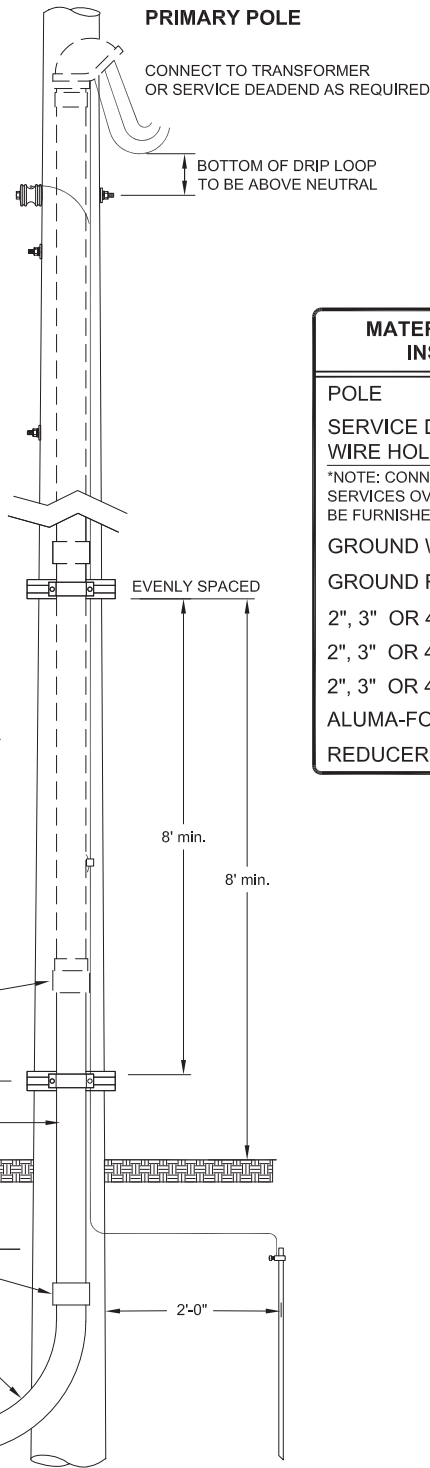

MATERIALS FURNISHED AND INSTALLED BY NHEC

POLE

SERVICE DROP CONDUCTORS, WIRE HOLDER & CONNECTORS*
*NOTE: CONNECTORS FOR SERVICES OVER 500 MCM, WILL BE FURNISHED BY CONSUMER.

GROUND WIRE

GROUND ROD AND CONNECTOR

2", 3" OR 4" WEATHER HEAD

2", 3" OR 4" CONDUIT

2", 3" OR 4" COUPLING

ALUMA-FORM STANDOFF BRACKETS

REDUCER TO 2" OR 3"

STANDOFF BRACKET IMPORTANT NOTES:

CONTRACTOR TO KEEP CONDUIT TO 7-1/2" FROM FACE OF POLE.

NHEC PERSONNEL WILL PROVIDE A STANDOFF BRACKET TO ASSIST STEEL SWEEP DISTANCE TO THE POLE.

ALL CONDUIT ABOVE GRADE TO BE SCHEDULE 80 PVC.

ASSEMBLY FOR USING STANDOFF BRACKET

2" CONDUIT: UJ3 - 2

3" CONDUIT: UJ3 - 3

4" CONDUIT: UJ3 - 4

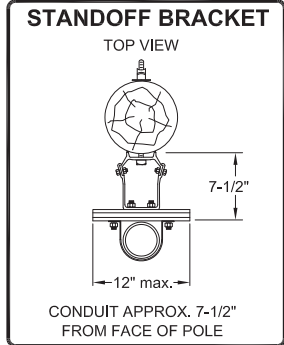

NOTES:

- 1.) All conduit and accessories must meet electrical grade specifications.
- 2.) All member furnished material to be on hand, and all necessary excavation and conduit ready prior to time of installation of equipment on pole by NHEC personnel.
- 3.) Conduit to be on quadrant of pole opposite flow of traffic.
- 4.) Refer to Underground Service Installation Section for further clarification and detailed descriptions for underground installations.



CONSTRUCTION STANDARDS
SINGLE RESIDENCE
400 AMP SERVICE OR LESS
PRIMARY POLE WITH OFFSET

UJ3 - 2
UJ3 - 3
UJ3 - 4

ISSUE DATE: 9/22

INSTALLATION REQUIREMENTS FOR UNDERGROUND SERVICE

UJ3 - 2C
UJ3 - 3C
UJ3 - 4C

MATERIALS FURNISHED AND INSTALLED BY MEMBER

USE 3" CONDUIT FOR 200 AMP SERVICE AND 4" FOR SERVICES GREATER THAN 200 AMPS

- ① **3" OR 4" CONDUIT**
SCHEDULE 80 PVC.
- ② **3" OR 4" 90°, 36" RADIUS SWEEP**
SEE NOTE #4
- ③ **3" OR 4" ADAPTER**
(IF NEEDED)
- ④ **3" OR 4" CONDUIT**
SCHEDULE 40 PVC
- ⑤ **RED CAUTION RIBBON**
6" WIDE CAUTION RIBBON. MUST SAY "ELECTRICAL LINE BURIED BELOW".
- ⑥ **1/4" POLYPROPYLENE STRING**
INSTALLED IN ALL CONDUITS WITH STRING EXPOSED AND TIED OFF AT ENDS THRU CAPS AT END OF CONDUIT.

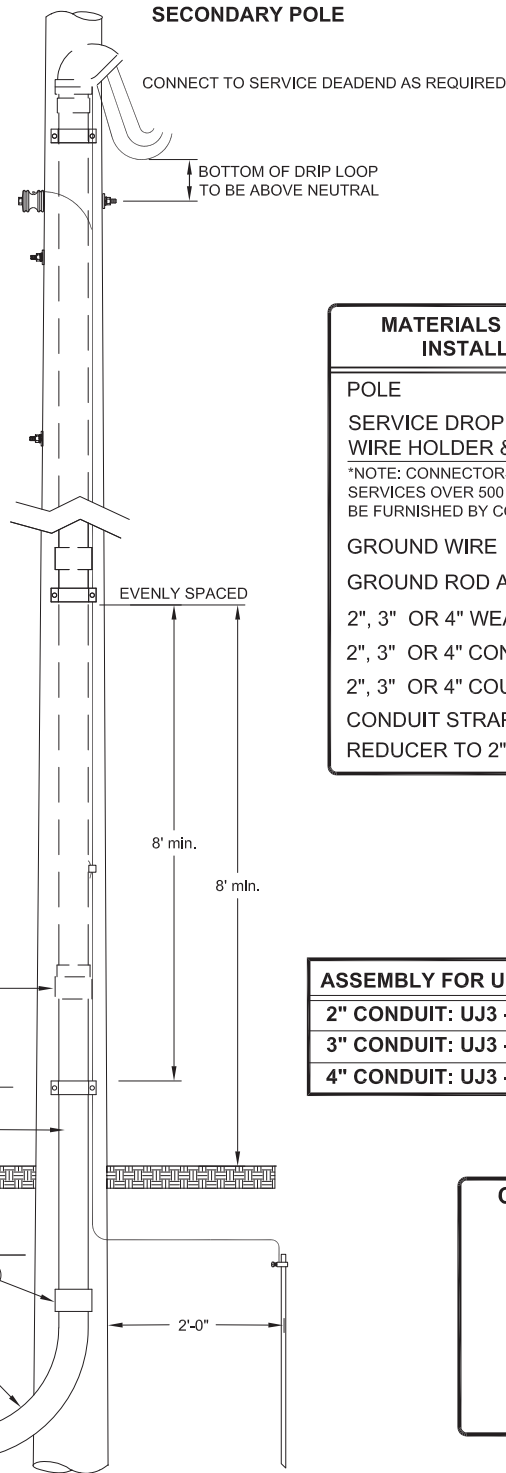

MATERIALS FURNISHED AND INSTALLED BY NHEC

POLE

SERVICE DROP CONDUCTORS,
WIRE HOLDER & CONNECTORS*

*NOTE: CONNECTORS FOR SERVICES OVER 500 MCM, WILL BE FURNISHED BY CONSUMER.

GROUND WIRE

GROUND ROD AND CONNECTOR
2", 3" OR 4" WEATHER HEAD
2", 3" OR 4" CONDUIT
2", 3" OR 4" COUPLING
CONDUIT STRAPS
REDUCER TO 2" OR 3"

ASSEMBLY FOR USING CONDUIT CLIPS

2" CONDUIT:	UJ3 - 2C
3" CONDUIT:	UJ3 - 3C
4" CONDUIT:	UJ3 - 4C

CONDUIT STRAPS

TOP VIEW

CONDUIT STRAPPED ON FACE OF POLE

ALL CONDUIT ABOVE GRADE TO BE SCHEDULE 80 PVC.

CONSUMER TO END CONDUIT APPROXIMATELY 1' ABOVE BRACKET

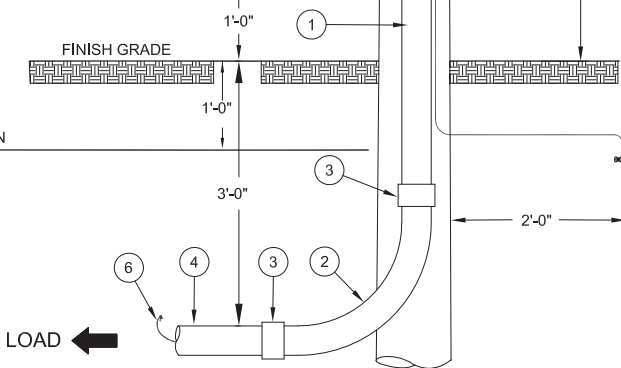

NOTES:

- 1.) All conduit and accessories must meet electrical grade specifications.
- 2.) All member furnished material to be on hand, and all necessary excavation and conduit ready prior to time of installation of equipment on pole by NHEC personnel.
- 3.) Conduit to be on quadrant of pole opposite flow of traffic.
- 4.) Refer to Underground Service Installation Section for further clarification and detailed descriptions for underground installations.



CONSTRUCTION STANDARDS
SINGLE RESIDENCE
400 AMP SERVICE OR LESS
SECONDARY POLE WITH CLIPS

UJ3 - 2C
UJ3 - 3C
UJ3 - 4C
ISSUE DATE: 9/22

MATERIALS FURNISHED AND INSTALLED BY MEMBER

- ① **4" CONDUIT**
SCHEDULE 80 PVC
- ② **4" 90°, 36" RADIUS SWEEP**
GALVANIZED STEEL
- ③ **4" ADAPTER**
(IF NEEDED)
- ④ **4" CONDUIT**
SCHEDULE 40 PVC
- ⑤ **1/4" POLYPROPYLENE STRING**
INSTALLED IN ALL CONDUITS WITH STRING EXPOSED AND TIED OFF AT ENDS THRU CAPS AT END OF CONDUIT.
- ⑥ **#6 SOLID BARE GROUND WIRE**
- ⑦ **RED CAUTION RIBBON**
6" WIDE CAUTION RIBBON. MUST SAY "ELECTRICAL LINE BURIED BELOW".

MATERIALS FURNISHED AND INSTALLED BY NHEC

- POLE
- GROUND ROD AND CONNECTOR
- ALUMA-FORM STANDOFF BRACKETS

STANDOFF BRACKET IMPORTANT NOTES:

CONTRACTOR TO KEEP CONDUIT TO 7-1/2" FROM FACE OF POLE.

NHEC PERSONNEL WILL PROVIDE A STANDOFF BRACKET TO ASSIST STEEL SWEEP DISTANCE TO THE POLE.

STANDOFF BRACKET

TOP VIEW

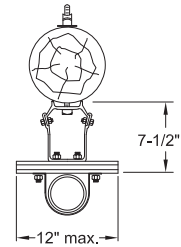

CONDUIT APPROX. 7-1/2" FROM FACE OF POLE

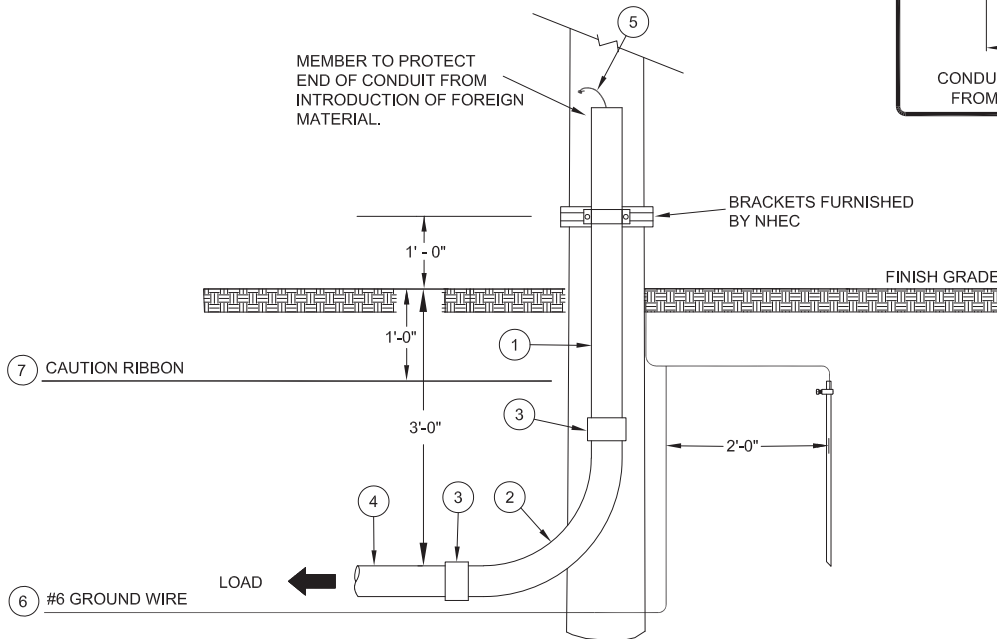

NOTES:

- 1.) All member furnished material to be on hand, and all necessary excavation and conduit ready prior to time of installation of equipment on pole by NHEC personnel.
- 2.) Conduit to be on quadrant of pole opposite flow of traffic.
- 3.) Refer to Underground Service Installation Section for further clarification and detailed descriptions for underground installations.



CONSTRUCTION STANDARDS
UNDERGROUND PRIMARY
RADIAL FEED - SINGLE TRANSFORMER
PRIMARY POLE MATERIALS

URD 1A

ISSUE DATE: 9/22

MATERIALS FURNISHED AND INSTALLED BY MEMBER

- ① **4" CONDUIT**
SCHEDULE 80 PVC
- ② **4" 90°, 36" RADIUS SWEEP**
GALVANIZED STEEL
- ③ **4" ADAPTER**
(IF NEEDED)
- ④ **4" CONDUIT**
SCHEDULE 40 PVC
- ⑤ **CONDUIT END CAPS**
- ⑥ **1/4" POLYPROPYLENE STRING**
INSTALLED IN ALL CONDUITS WITH STRING EXPOSED AND TIED OFF AT ENDS THRU CAPS AT END OF CONDUIT.
- ⑦ **#6 SOLID BARE GROUND WIRE**
- ⑧ **RED CAUTION RIBBON**
6" WIDE CAUTION RIBBON. MUST SAY " ELECTRICAL LINE BURIED BELOW ".

MATERIALS FURNISHED AND INSTALLED BY NHEC

- POLE
- GROUND ROD AND CONNECTOR
- ALUMA-FORM STANDOFF BRACKETS

STANDOFF BRACKET IMPORTANT NOTES:

CONTRACTOR TO KEEP CONDUIT TO 7-1/2" FROM FACE OF POLE.

NHEC PERSONNEL WILL PROVIDE A STANDOFF BRACKET TO ASSIST STEEL SWEEP DISTANCE TO THE POLE.

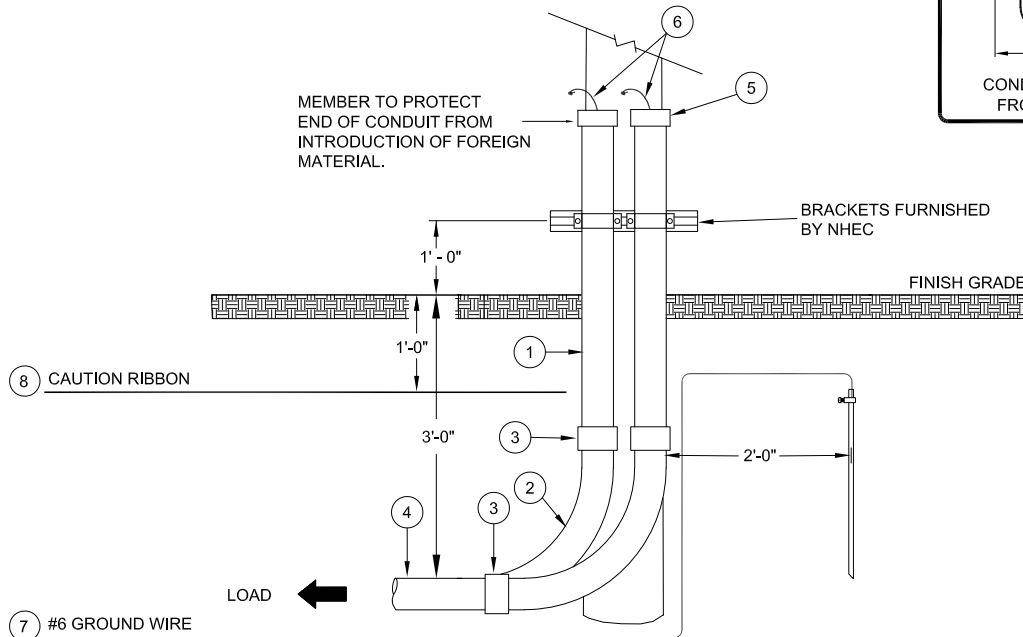
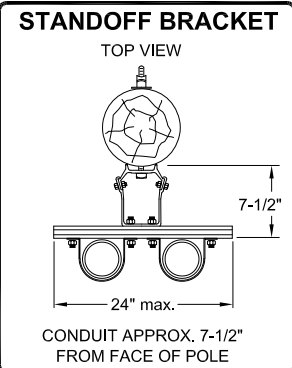

NOTES:

- 1.) All member furnished material to be on hand, and all necessary excavation and conduit ready prior to time of installation of equipment on pole by NHEC personnel.
- 2.) Conduit to be on quadrant of pole opposite flow of traffic.
- 3.) Refer to Underground Service Installation Section for further clarification and detailed descriptions for underground installations.

BACKFILL AROUND VAULT MUST BE FLAT AND LEVEL FOR A MINIMUM WIDTH OF 3 FT. ON ALL SIDES.

PAD & COVER REQUIREMENTS
 FOR SINGLE PHASE TRANSFORMERS
 USE PAD U6-5A AND WHEN USED AS A
 PULLING VAULT USE COVER U7-5B.
 (NOT SHOWN IN TOP VIEW)

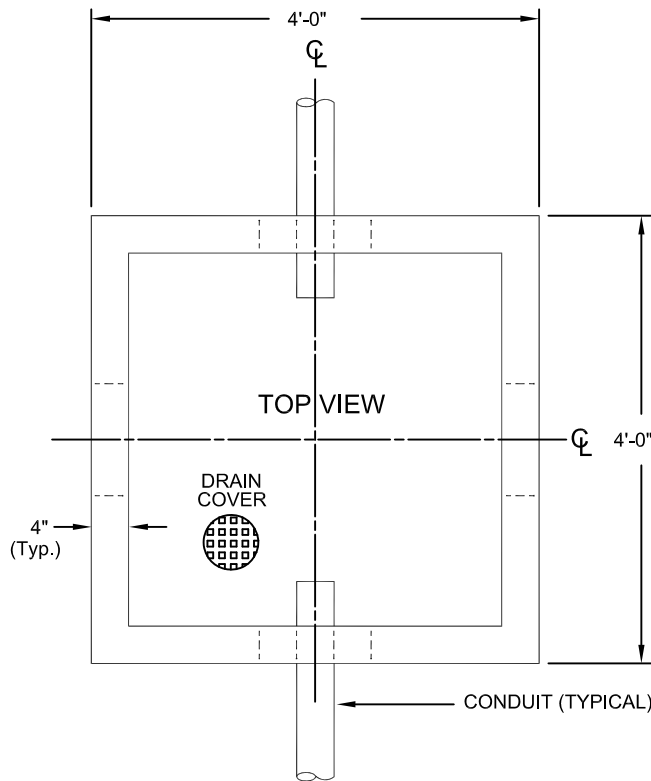
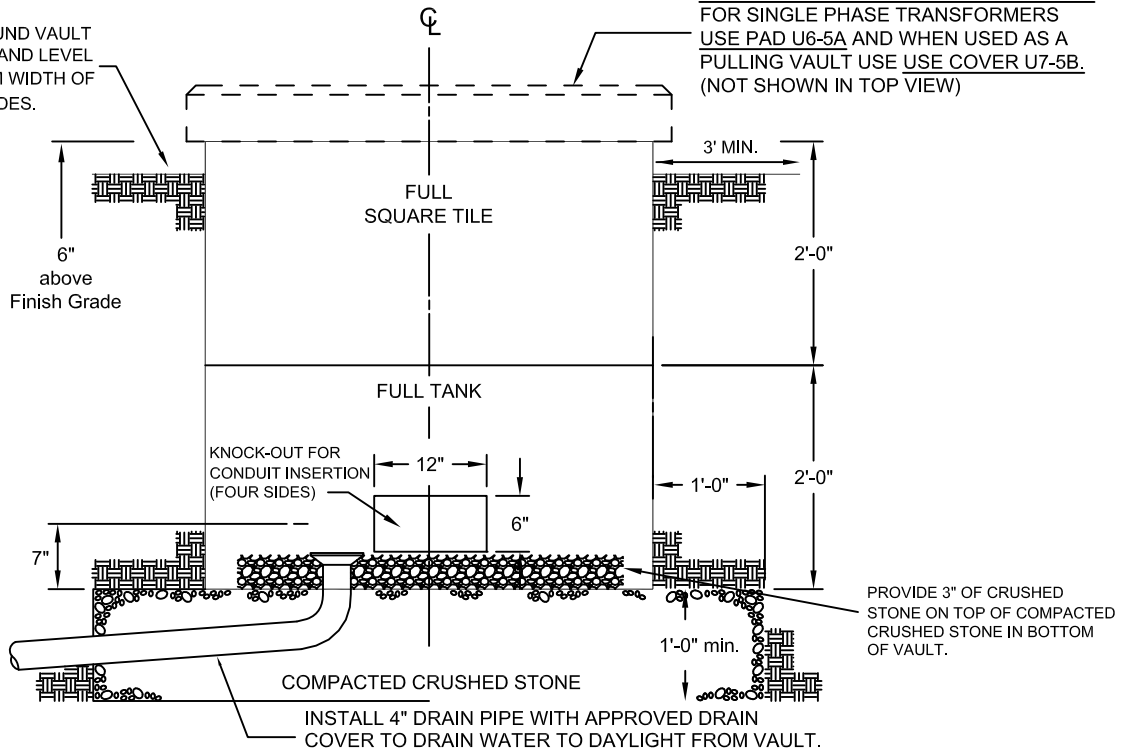

INSTALLATION REQUIREMENTS

- 1.) If the vault is cut into an embankment, NHEC may require a retaining wall either in front or behind the vault to prevent material from spilling into or away from the vault.
- 2.) Top of vault shall be six inches above finished grade.
- 3.) All vaults will be constructed with a drainage system of approved pipe material to drain water that may penetrate the vault. The piping shall originate at the lowest point inside the vault and be routed to free air at an elevation below its origination that promotes drainage.
- 4.) If vault is located near the traveled way, NHEC may require a protective structure to prevent damage.
- 5.) Seal all knockouts after conduit is placed.
- 6.) Concrete shall have a compressive strength of 5000 P.S.I. after 28 days when tested in accordance with ASTM C-39-72 (Latest edition).
- 7.) Refer to Member Handbook Underground Service Installation Section for further clarification and detailed descriptions for underground installations.

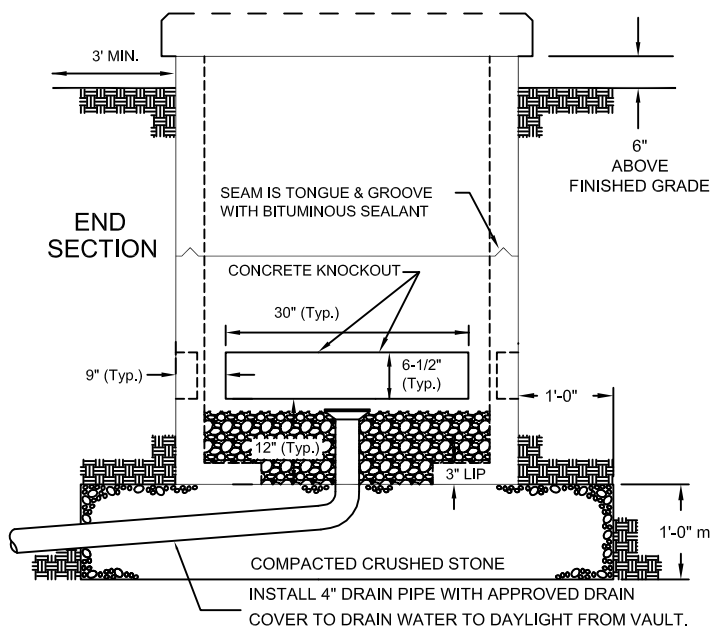
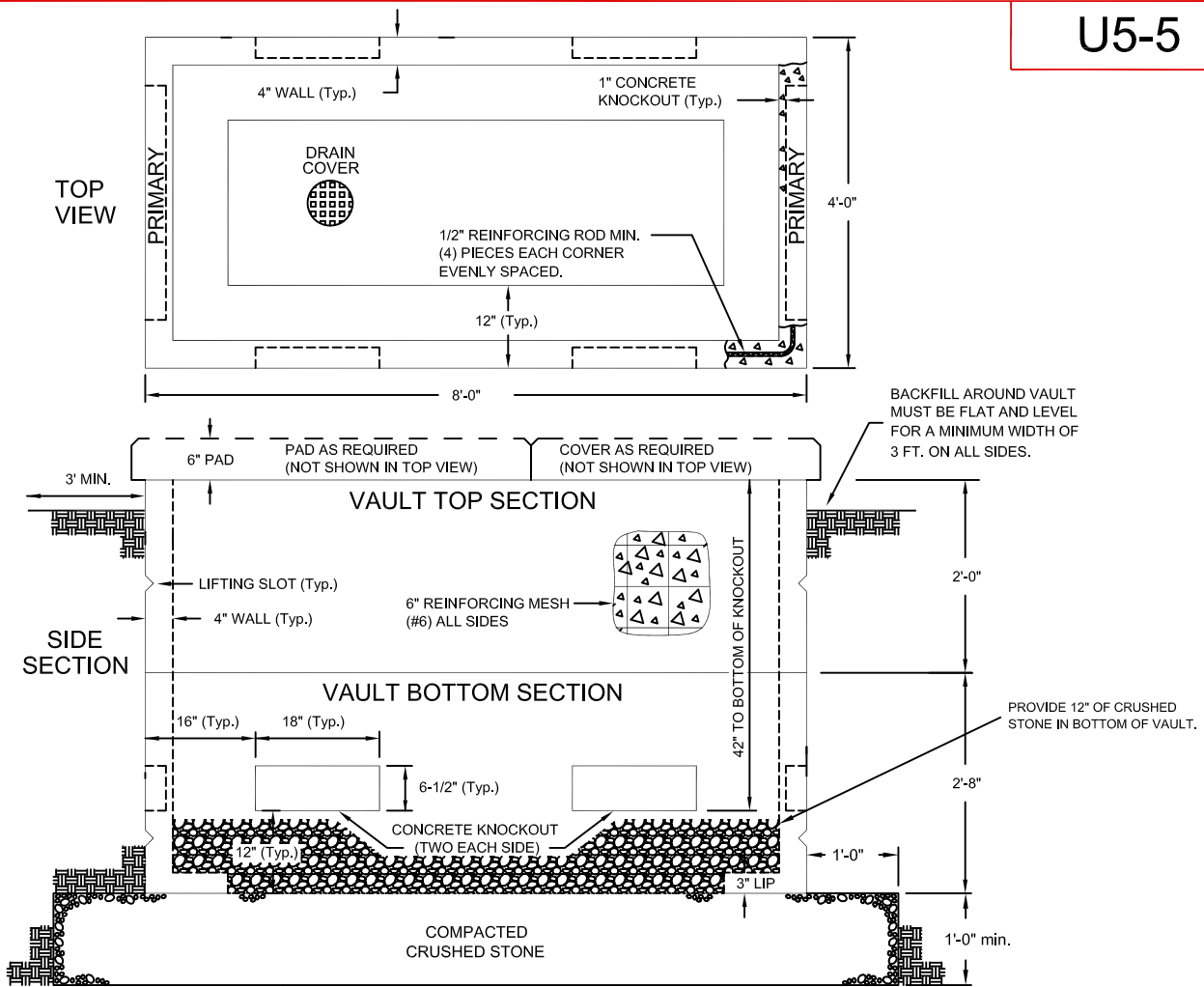

INSTALLATION REQUIREMENTS

- 1.) If the vault is cut into an embankment, NHEC may require a retaining wall either in front or behind the vault to prevent material from spilling into or away from the vault.
- 2.) Top of vault shall be six inches above finished grade.
- 3.) All vaults will be constructed with a drainage system of approved pipe material to drain water that may penetrate the vault. The piping shall originate at the lowest point inside the vault and be routed to free air at an elevation below its origination that promotes drainage.
- 4.) If vault is located near the traveled way, NHEC may require a protective structure to prevent damage.
- 5.) Seal all knockouts after conduit is placed.
- 6.) Concrete shall have a compressive strength of 5000 P.S.I. after 28 days when tested in accordance with ASTM C-39-72 (Latest edition).
- 7.) Refer to Member Handbook Underground Service Installation Section for further clarification and detailed descriptions for underground installations.

PAD & COVER REQUIREMENTS

- 1.) For single phase 15 or 25kV transformer (15-167kVA), use Pad U6-5A & Cover U7-5B.
- 2.) For single phase 15 or 25kV 200 amp sectionalizing cabinet use Pad U6-5B & Cover U7-5B.
- 3.) For splicing or pulling vault use Cover U7-5A & Cover U7-5B.



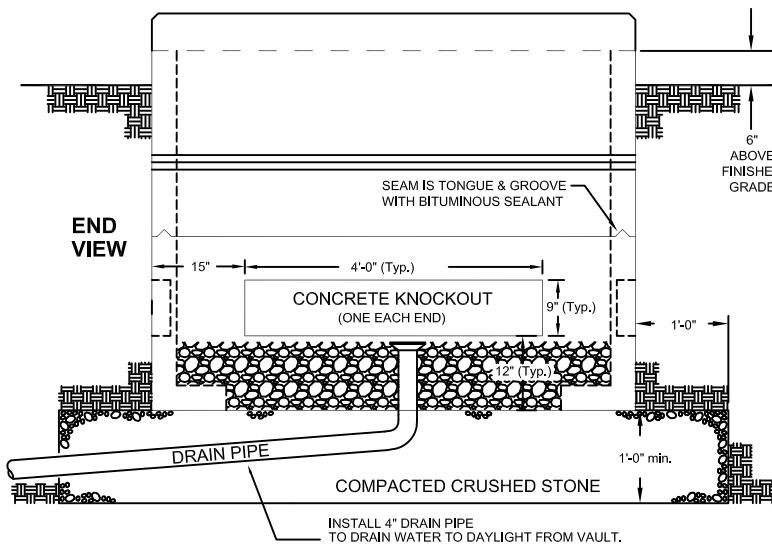
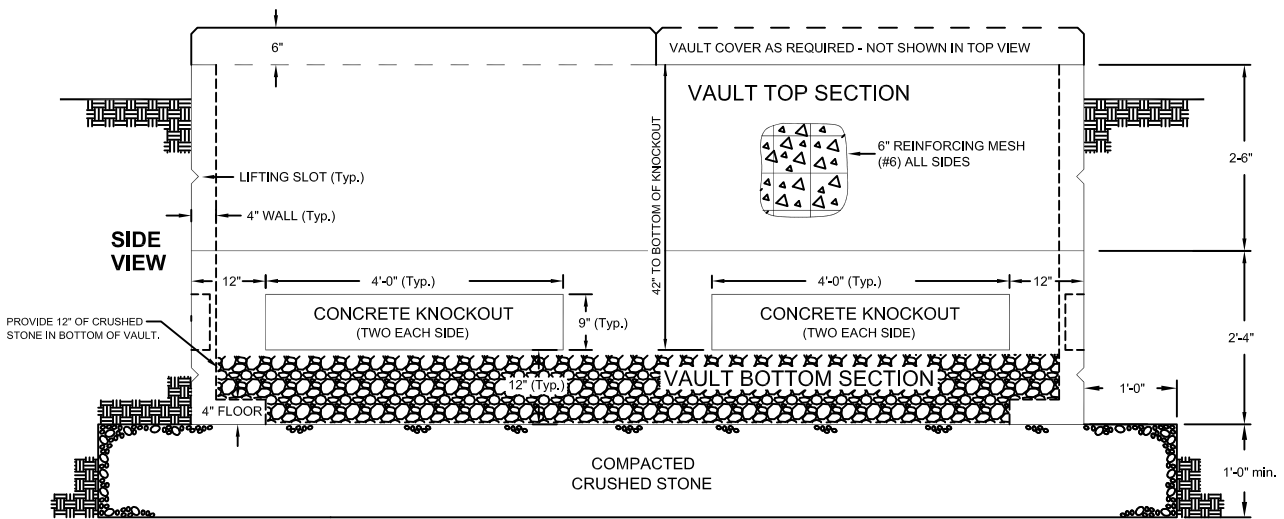
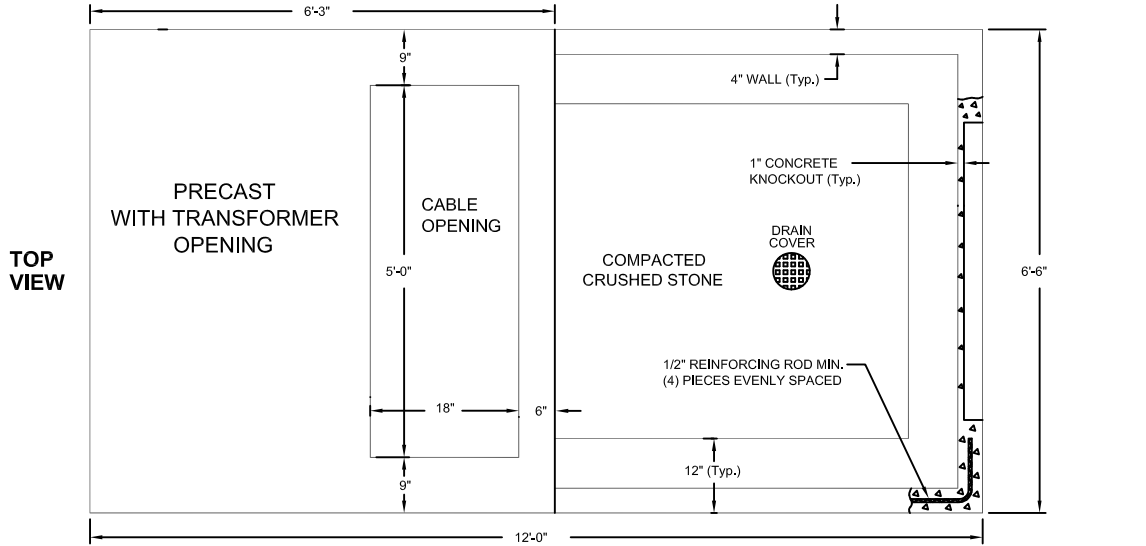

INSTALLATION REQUIREMENTS

- 1.) If the vault is cut into an embankment, NHEC may require a retaining wall either in front or behind the vault to prevent material from spilling into or away from the vault.
- 2.) Top of vault shall be six inches above finished grade.
- 3.) All vaults will be constructed with a drainage system of approved pipe material to drain water that may penetrate the vault. The piping shall originate at the lowest point inside the vault and be routed to free air at an elevation below its origination that promotes drainage.
- 4.) If vault is located near the traveled way, NHEC may require a protective structure to prevent damage.
- 5.) Seal all knockouts after conduit is placed.
- 6.) Concrete shall have a compressive strength of 5000 P.S.I. after 28 days when tested in accordance with ASTM C-39-72 (Latest edition).
- 7.) Refer to Member Handbook Underground Service Installation Section for further clarification and detailed descriptions for underground installations.

FURTHER REQUIREMENT INCLUDES:

- 1.) Vault cover U7-7E to enclose vault.
- 2.) Approximate weights:
 Vault top section 5600 Lbs.
 Vault bottom section 5300 Lbs.
 Vault cover U7-7E 2600 Lbs.



**CONSTRUCTION STANDARDS
 PRECAST VAULT ASSEMBLY
 FOR
 3-PHASE TRANSFORMERS**

U5-7S

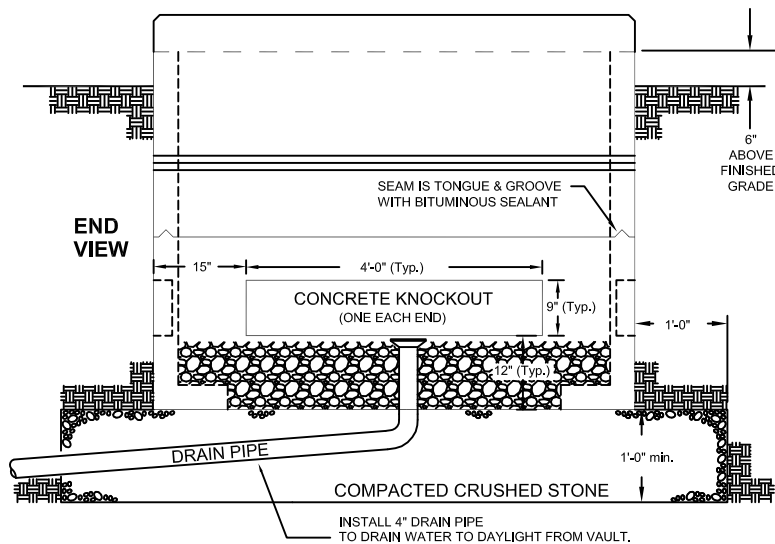
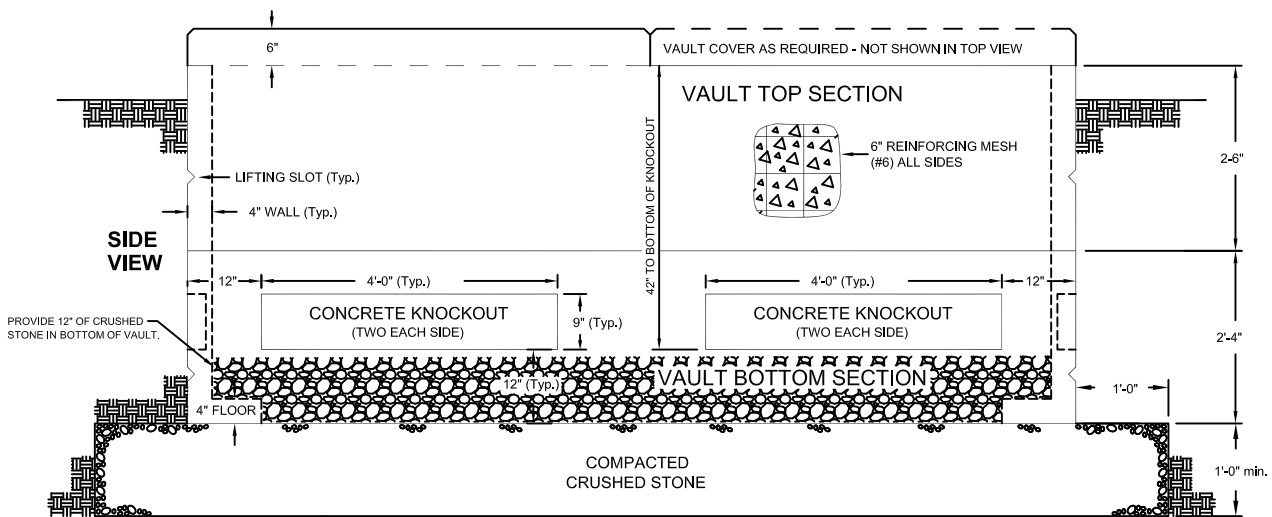
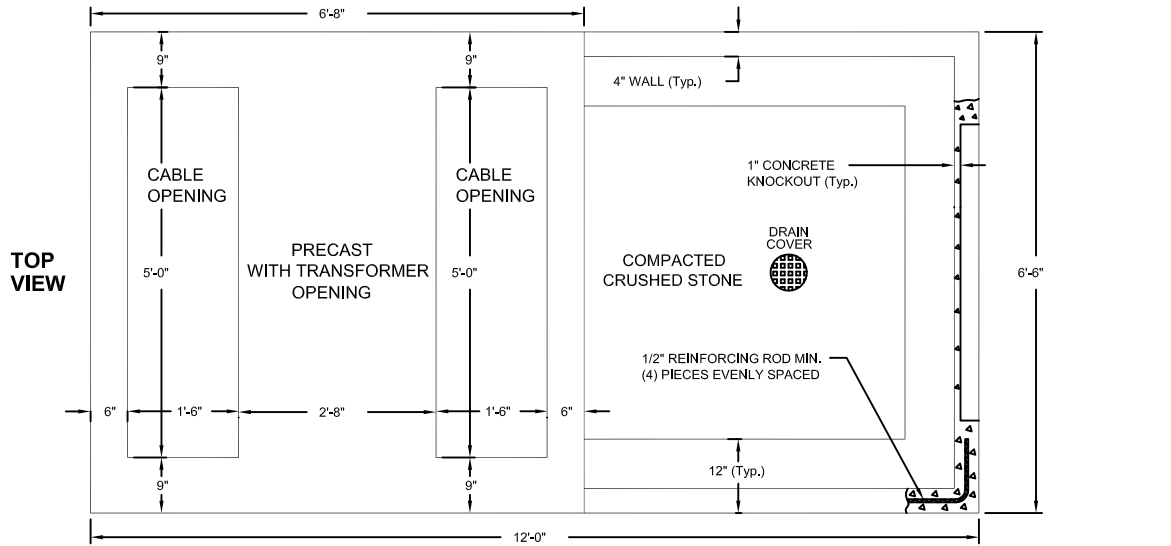

INSTALLATION REQUIREMENTS

- 1.) If the vault is cut into an embankment, NHEC may require a retaining wall either in front or behind the vault to prevent material from spilling into or away from the vault.
- 2.) Top of vault shall be six inches above finished grade.
- 3.) All vaults will be constructed with a drainage system of approved pipe material to drain water that may penetrate the vault. The piping shall originate at the lowest point inside the vault and be routed to free air at an elevation below its origination that promotes drainage.
- 4.) If vault is located near the traveled way, NHEC may require a protective structure to prevent damage.
- 5.) Seal all knockouts after conduit is placed.
- 6.) Concrete shall have a compressive strength of 5000 P.S.I. after 28 days when tested in accordance with ASTM C-39-72 (Latest edition).
- 7.) Refer to Member Handbook Underground Service Installation Section for further clarification and detailed descriptions for underground installations.

FURTHER REQUIREMENT INCLUDES:

- 1.) Vault cover U7-7E to enclose vault.
- 2.) Approximate weights:

Vault top section	5600 Lbs.
Vault bottom section	5300 Lbs.
Vault cover U7-7E	2600 Lbs.



CONSTRUCTION STANDARDS PRECAST VAULT ASSEMBLY FOR 3-PHASE 600 AMP SECTIONALIZER

U5-7S

ISSUE DATE: 9/22

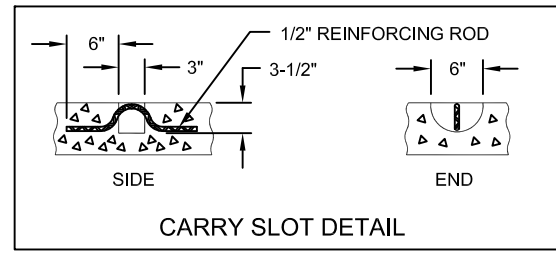
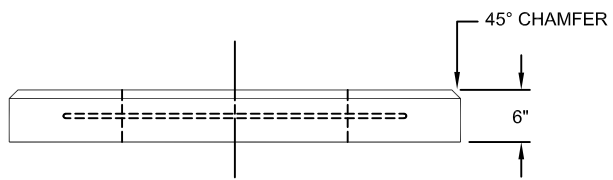
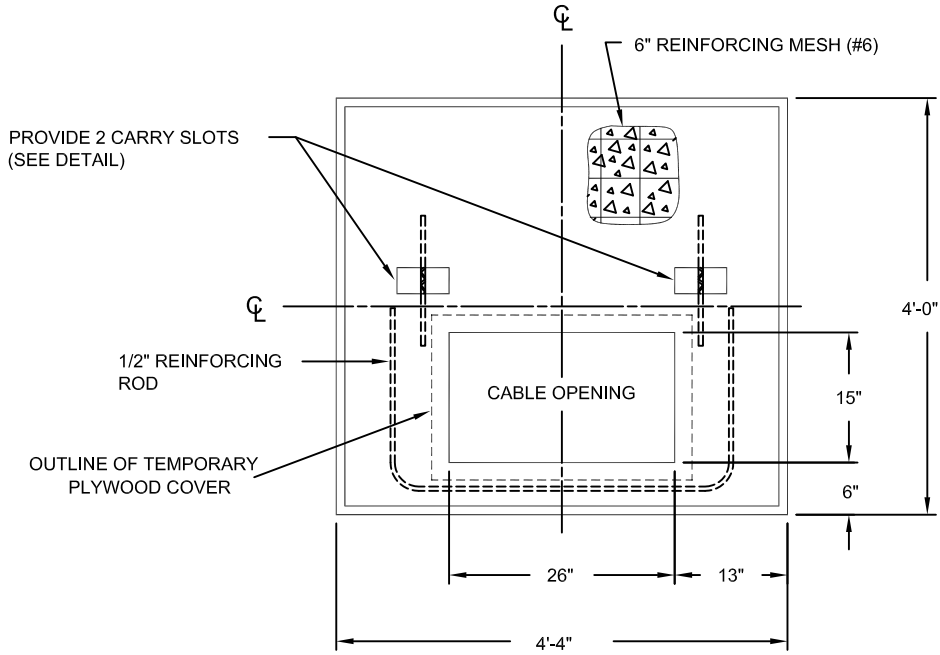

NOTE:

- 1.) CONCRETE SHALL HAVE A COMPRESSIVE STRENGTH OF 5000 P.S.I. AFTER 28 DAYS WHEN TESTED IN ACCORDANCE WITH ASTM C 39-72 (LATEST EDITION).
- 2.) USE COVER U7-5B WITH VAULT U5-5.
- 3.) CONTRACTOR IS RESPONSIBLE TO COVER CABLE OPENING UNTIL NHEC BEGINS WORK. SEE DRAWING BELOW FOR RECOMMENDED COVER ATTACHMENT.

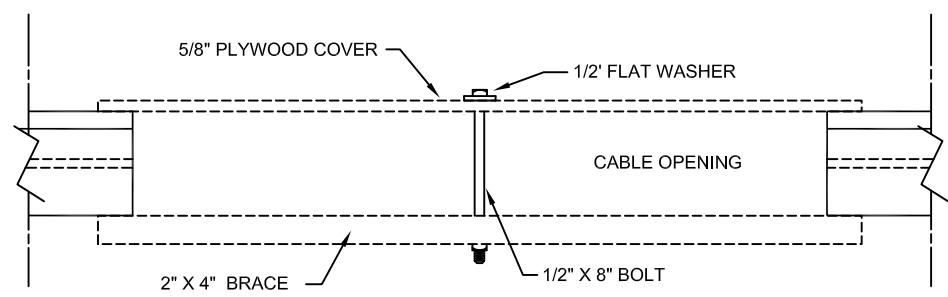

PARTIAL SECTION AT CABLE OPENING



CONSTRUCTION STANDARDS
 SINGLE PHASE TRANSFORMER
 VAULT PAD FOR U5-5 & U5-4
 INCLUDING TEMPORARY CABLE OPENING COVER

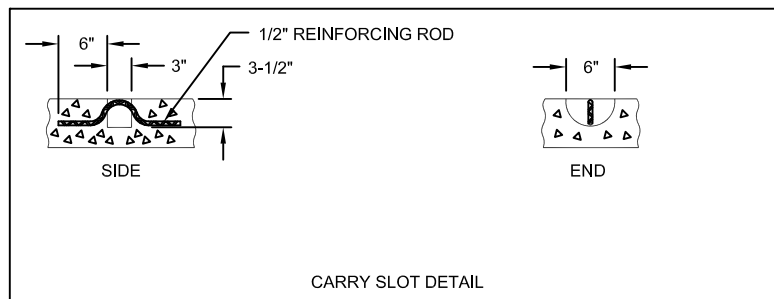
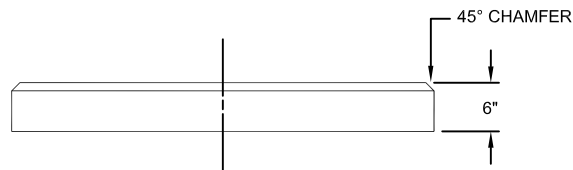
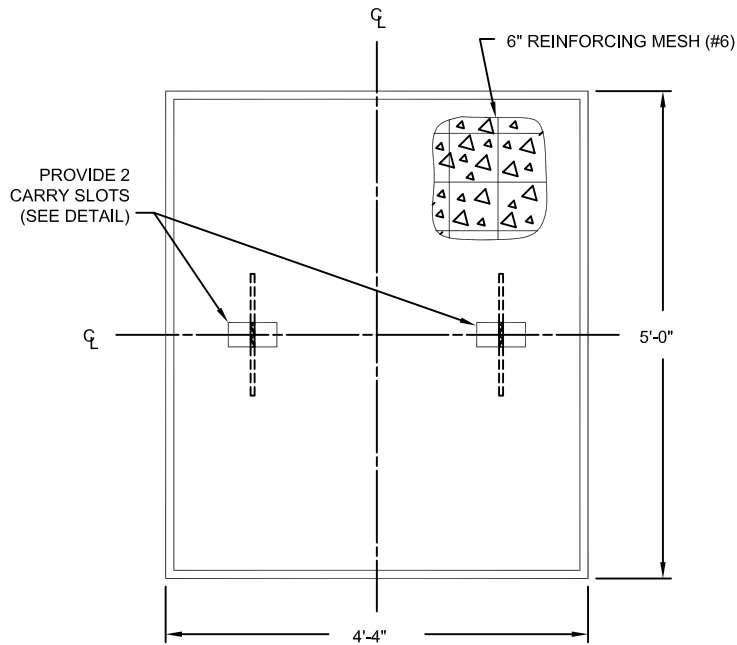

NOTE:

- 1.) CONCRETE SHALL HAVE A COMPRESSIVE STRENGTH OF 5000 P.S.I. AFTER 28 DAYS WHEN TESTED IN ACCORDANCE WITH ASTM C 39-72 (LATEST EDITION)
- 2.) APPROXIMATE WEIGHT: 1515 LBS.

ONE OR MORE PRIMARY CIRCUITS WITH TELEPHONE AND/OR CABLE TV

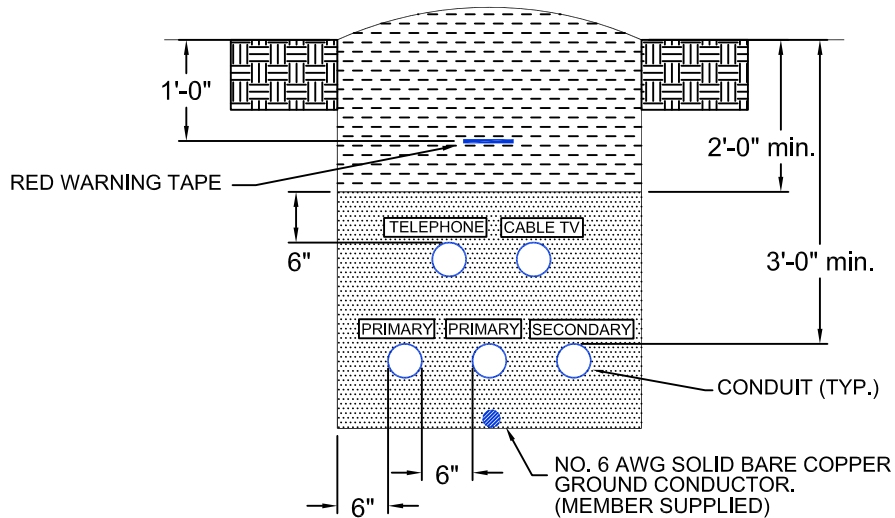

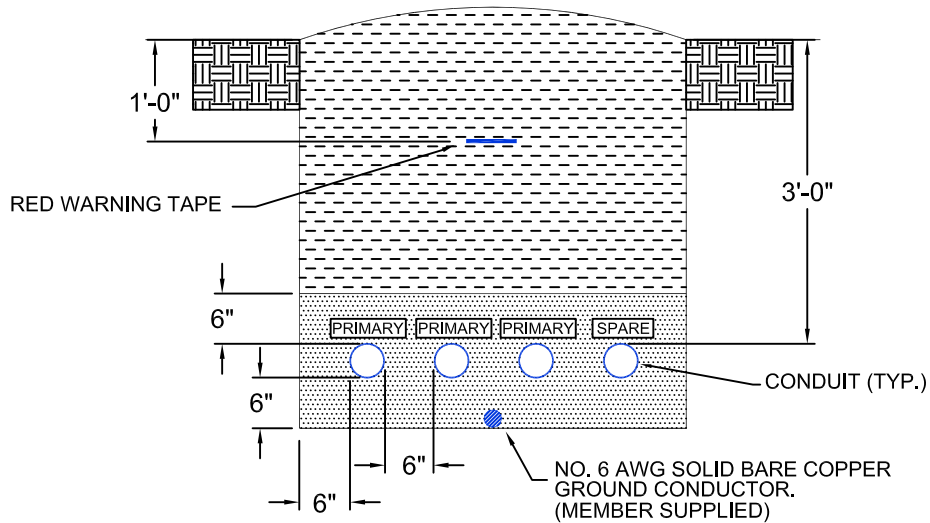

PRIMARY CIRCUIT WITH SPARE



NOTE:

1. TRENCH WIDTH AS REQUIRED TO MAINTAIN 6" MINIMUM SPACING BETWEEN ALL CONDUITS AND TRENCH SIDEWALLS.
2. TRENCH TO BE INSPECTED BY A REPRESENTATIVE OF NHEC PRIOR TO BACKFILLING.
3. REFER TO MEMBER HANDBOOK UNDERGROUND INSTALLATION SECTION FOR FURTHER CLARIFICATION AND DETAILED DESCRIPTIONS FOR UNDERGROUND INSTALLATIONS.

 <p>WHEEL COMPACTED BACKFILL, NO ROCKS LARGER THAN 6" DIAMETER</p>	 <p>SAND OR FINE BACKFILL, NO ROCKS LARGER THAN 1" DIAMETER</p>	 <p>UNDISTURBED EARTH</p>
---	--	--

ONE OR MORE SECONDARY CIRCUITS WITH TELEPHONE AND/OR CABLE TV

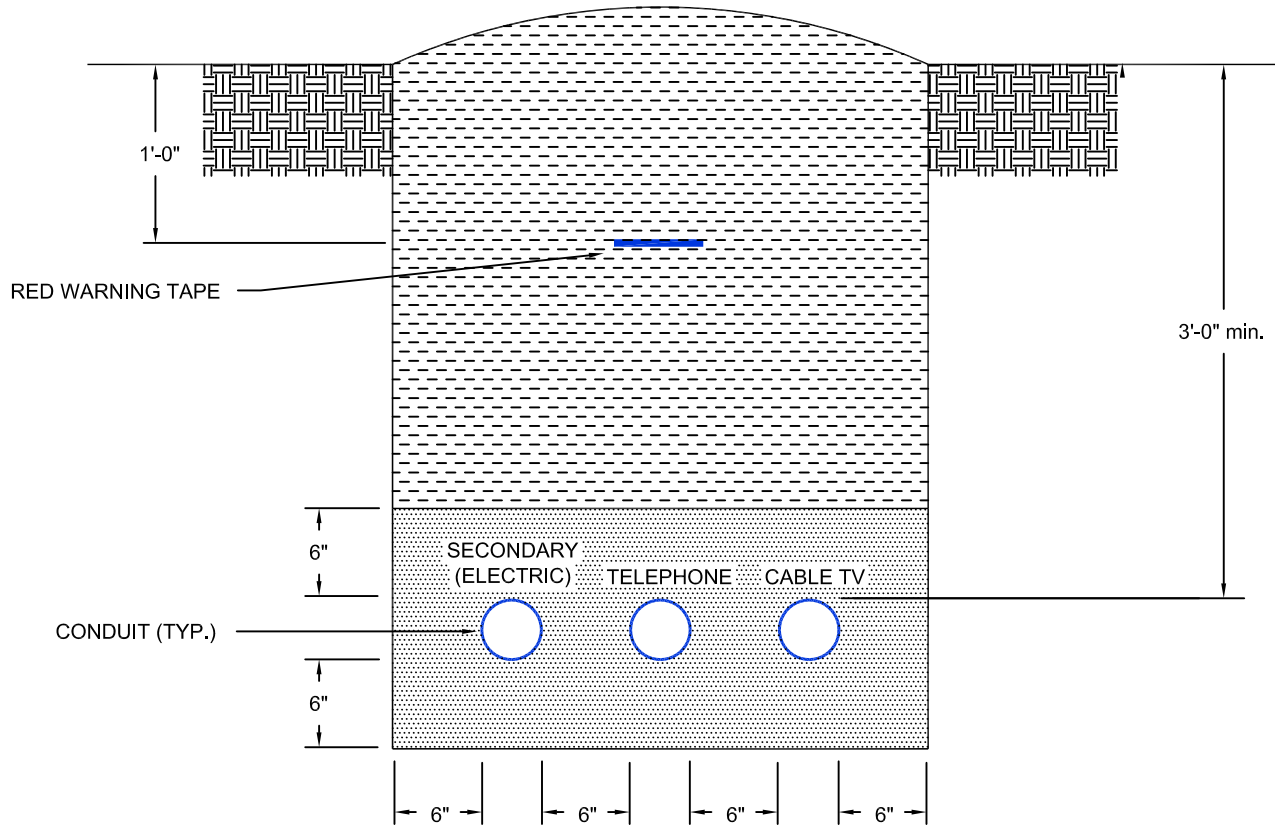

NOTE:

1. TRENCH WIDTH AS REQUIRED TO MAINTAIN 6" MINIMUM SPACING BETWEEN ALL CONDUITS AND TRENCH SIDEWALLS.
2. TRENCH TO BE INSPECTED BY A REPRESENTATIVE OF NHEC PRIOR TO BACKFILLING.



WHEEL COMPACTED BACKFILL,
NO ROCKS LARGER THAN 6"
DIAMETER



SAND OR FINE BACKFILL,
NO ROCKS LARGER THAN 1"
DIAMETER



UNDISTURBED EARTH



CONSTRUCTION STANDARDS
TRENCH FOR JOINT ELECTRIC
AND COMMUNICATION FACILITIES

IU Secondary Trench

ISSUE DATE: 06/05

CONCRETE CAPPED TRENCH

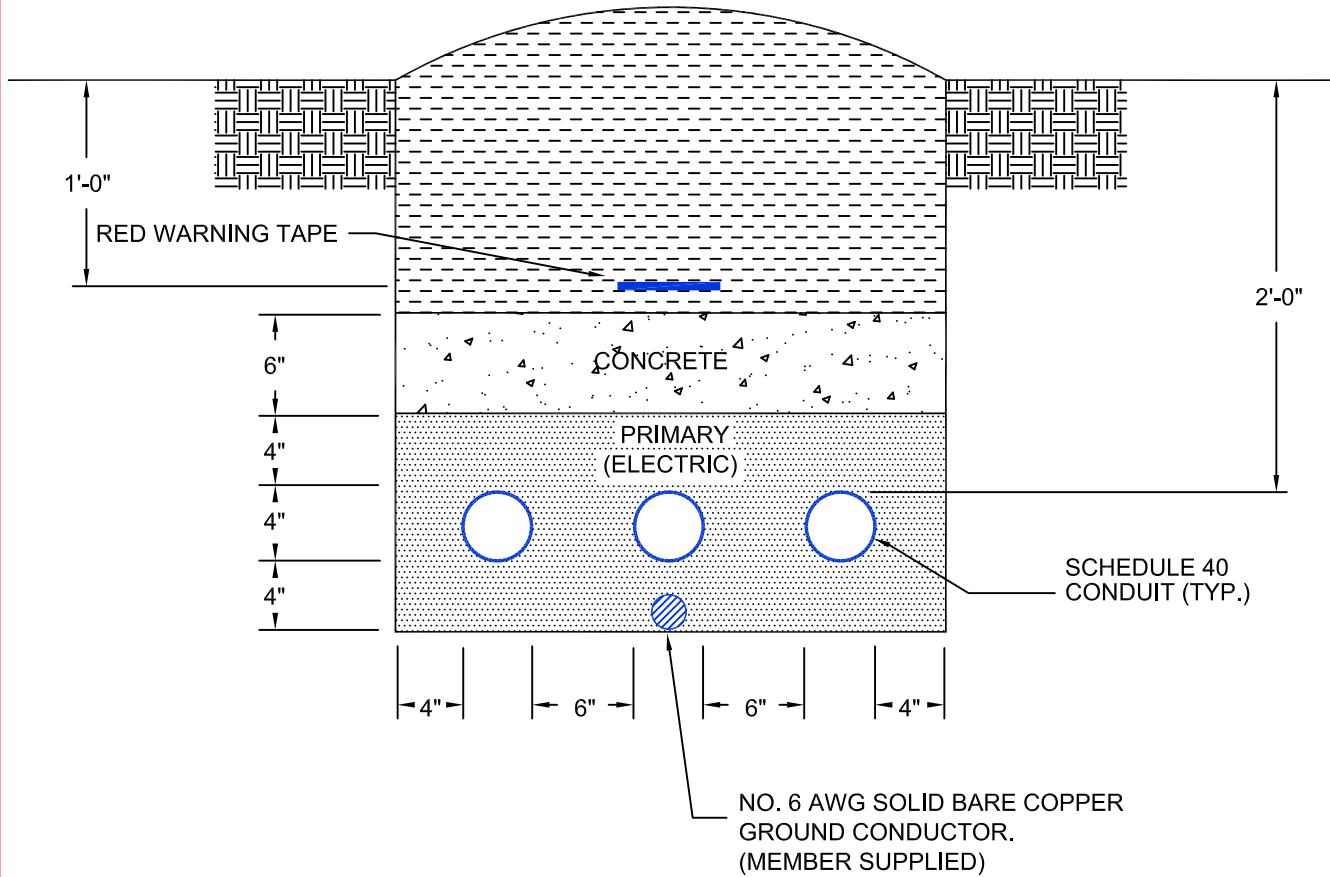

NOTE:

1. TRENCH WIDTH AS REQUIRED TO MAINTAIN 6" MINIMUM SPACING BETWEEN ALL CONDUITS AND 4" TO TRENCH SIDEWALLS.
2. CONCRETE TO BE 5000 PSI
3. TRENCH TO BE INSPECTED BY A REPRESENTATIVE OF NHEC PRIOR TO BACKFILLING.
4. REFER TO MEMBER HANDBOOK UNDERGROUND SERVICE INSTALLATION SECTION FOR FURTHER CLARIFICATION AND DETAILED DESCRIPTIONS FOR UNDERGROUND INSTALLATIONS.

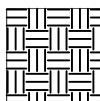

UNDISTURBED EARTH

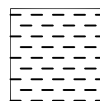

WHEEL COMPACTED BACKFILL,
NO ROCKS LARGER THAN 4"
DIAMETER

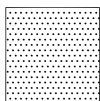

SAND OR FINE BACKFILL,
NO ROCKS LARGER THAN 1"
DIAMETER



5000 PSI CONCRETE ENCASEMENT

U7-6B

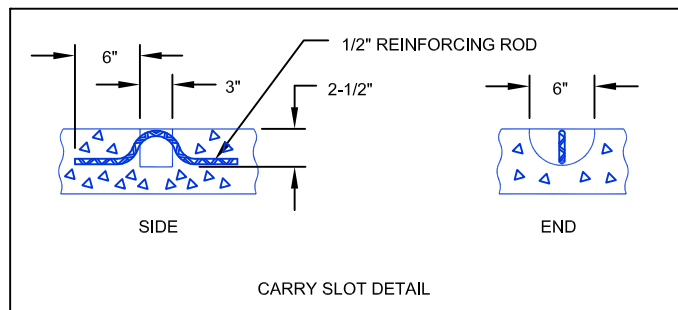
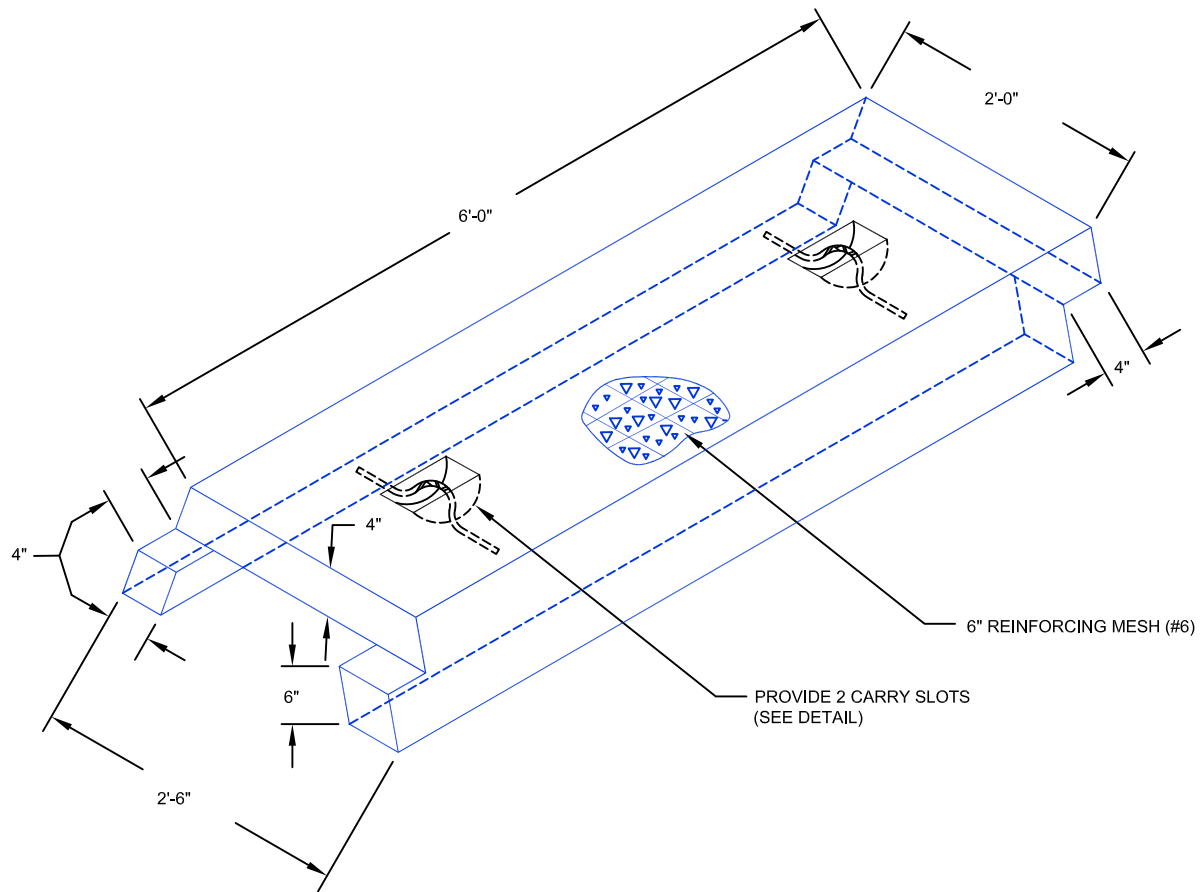

NOTE:

- 1.) CONCRETE SHALL HAVE A COMPRESSIVE STRENGTH OF 5000 P.S.I. AFTER 28 DAYS WHEN TESTED IN ACCORDANCE WITH ASTM C 39-72 (LATEST EDITION).



CONSTRUCTION STANDARDS

UNDERWATER CABLE COVER

U7-6B

REV. 11/26/2012

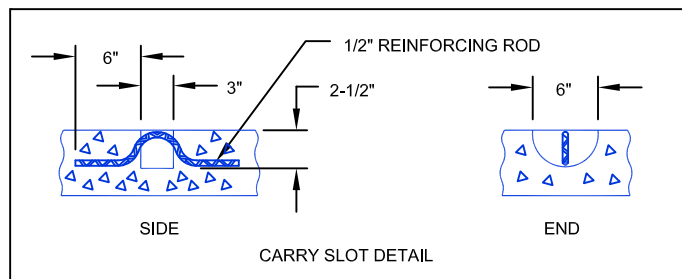
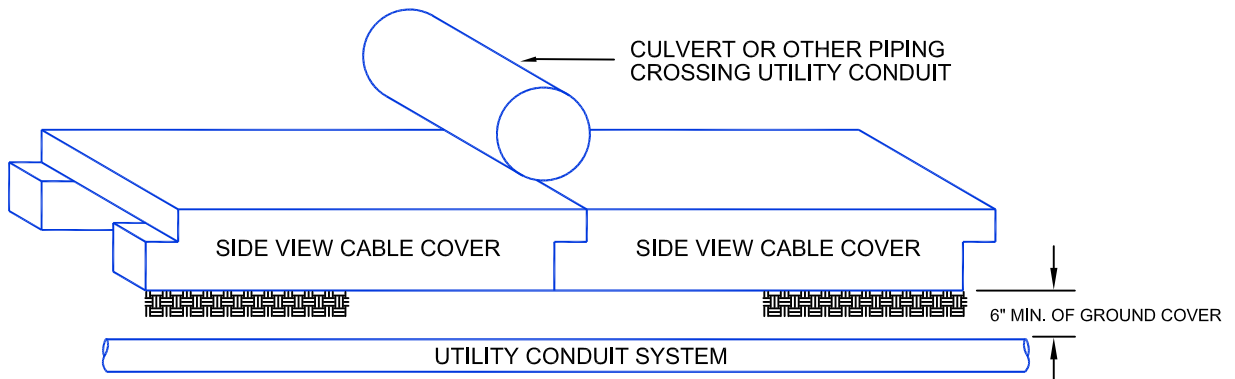
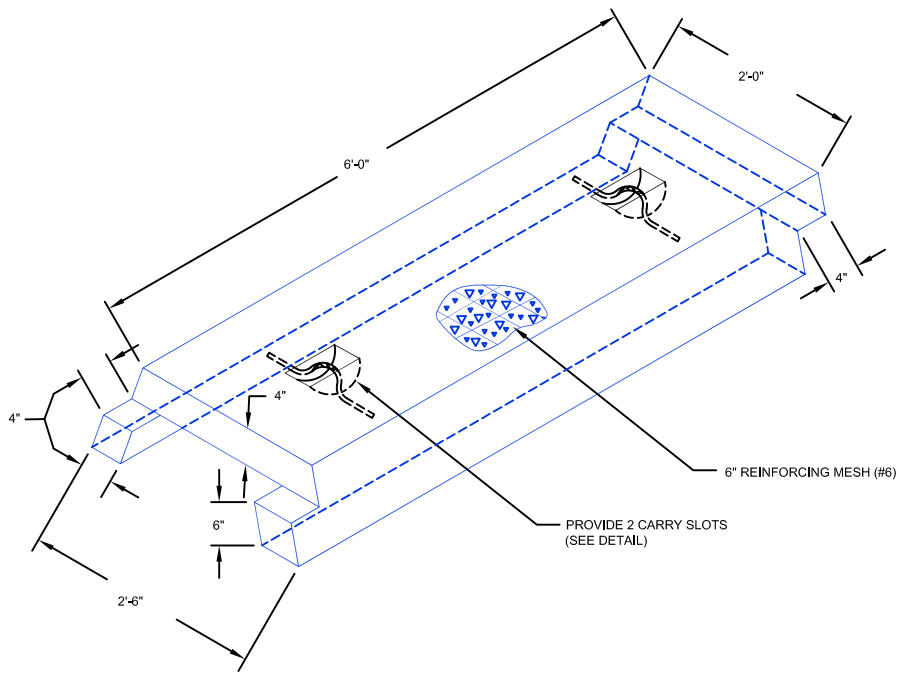

NOTE:

1.) CONCRETE SHALL HAVE A COMPRESSIVE STRENGTH OF 5000 P.S.I. AFTER 28 DAYS WHEN TESTED IN ACCORDANCE WITH ASTM C 39-72 (LATEST EDITION).

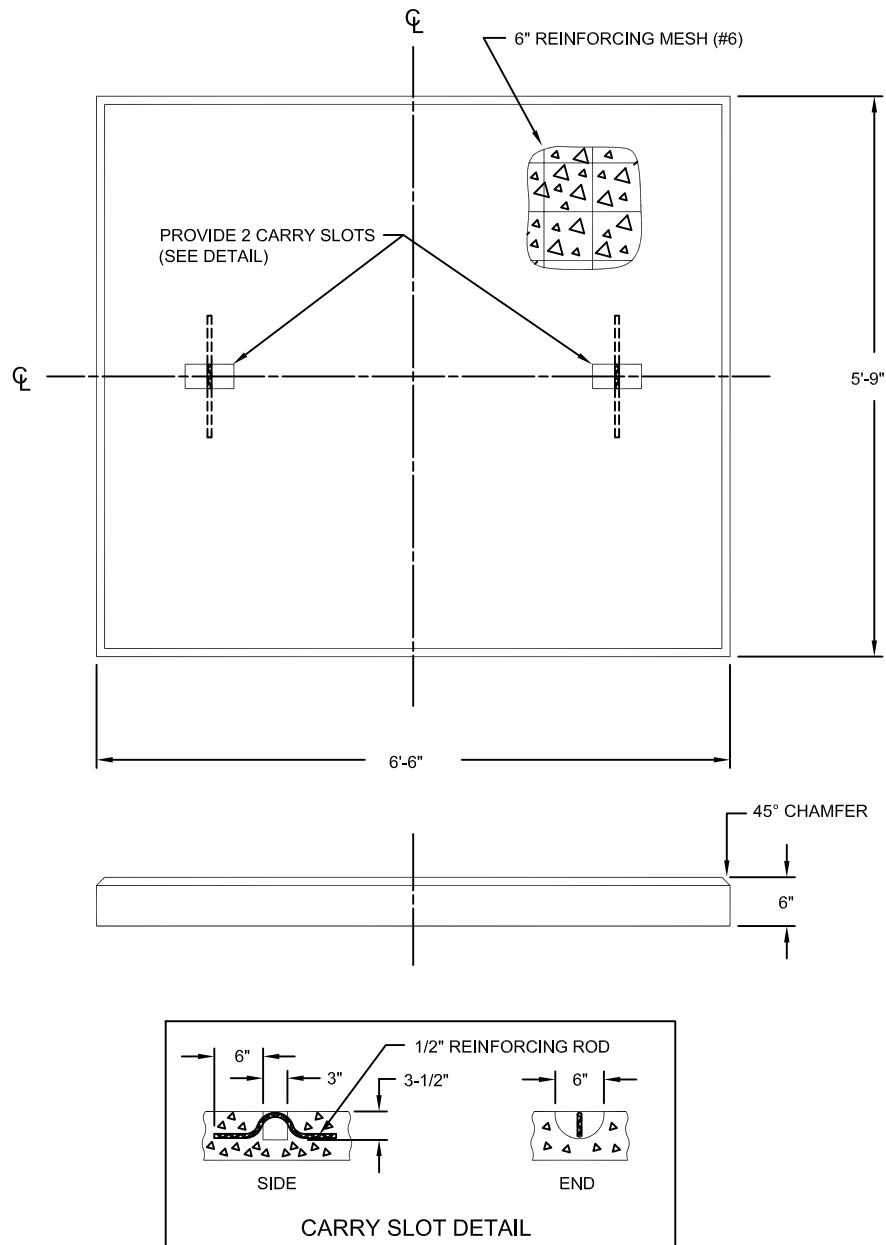

NOTE:

- 1.) CONCRETE SHALL HAVE A COMPRESSIVE STRENGTH OF 5000 P.S.I. AFTER 28 DAYS WHEN TESTED IN ACCORDANCE WITH ASTM C 39-72 (LATEST EDITION).
- 2.) APPROXIMATE WEIGHT: 2600 LBS.

Section 5: Utilization Equipment

GENERAL

When Member owned equipment could or actually does interfere with the operation of any components of NHEC's electric system or the electric supply to others, NHEC reserves the right to refuse service or to disconnect their supply upon proper notice. Such instances include, but are not limited to, harmonic distortion, voltage fluctuations, and unacceptable transformer and capacitor installations.

Members must consult with NHEC in advance of making any commitments for large motors, welders, X-ray machines, or other equipment which may have a high instantaneous electric demand. NHEC will determine the effect such installations have on NHEC's system. Should NHEC determine that the installation is likely to cause interference with the electric system or the electric supply to others, NHEC may refuse to connect service, discontinue service, or require the Member to make modifications to their system. It is the Member's responsibility to determine and correct the problems such equipment may have on their own system.

MOTOR INSTALLATIONS

The Member should ascertain from NHEC the character of service for the proposed location and application before purchasing motors and motor driven equipment. In general, motors of 3 hp. or less will be supplied from single phase services, and motors larger than 3 hp. will be supplied from three phase services.

The electrical limitations of the supply circuits may, in some cases, make it necessary to limit the size of the largest motor to be operated on any given part of NHEC's system. Written information as to such limitations is available upon inquiry to NHEC.

NOTICE OF CHANGE IN LOAD

If you are adding significant equipment or load you must notify NHEC to ensure this additional load will not adversely affect NHEC's system or other Members. Significant equipment on a small single- phase service would include, but is not limited to, such equipment as a welder or five horsepower motor. Significant equipment on the larger services would be anything that increases load by 10% and must have Engineering pre-approval.

- Under certain conditions where the quality of service to others is not impaired, NHEC may authorize the use of single-phase motors larger than 3 hp. Approval to install larger motors must be in writing.
- All motors should be equipped with suitable protective devices, to protect from the following conditions:
 - Overloads
 - Voltage and frequency variations
 - Single phase operation of polyphase motors
 - Reversal of rotation in polyphase motors
- NHEC will not be responsible for damage caused to Member owned equipment where such damage is caused by the absence, failure, or misapplication of any Member owned protective device.

- NHEC will not be held responsible for damage caused by lightning or other acts of nature.

VOLTAGE SENSITIVE EQUIPMENT

Members owning or planning to purchase computer, reproduction, X-ray equipment or other voltage sensitive equipment, should consult the manufacturer of their equipment, and install suitable devices their system to protect against power system transients and/or loss of voltage.

Section 6: Generating Equipment Owned by Members

GENERAL

The installation, connection, and operation of Member-owned generating equipment by a Member who takes service from NHEC may be restricted under the provisions of rates in NHEC's Tariff. The Member shall contact NHEC to obtain this information as part of the Member's planning to make an installation of generating equipment. Prior to operation of Member-owned generating equipment, NHEC shall have the right to inspect any Member-owned controlling and safety equipment associated with the generating equipment, together with the manner in which the generator is electrically connected to the Member's load and/or NHEC's electrical system to assure itself that the operation of this equipment will not create an undue risk of damage or injury to NHEC or its other Members.

STANDBY GENERATING EQUIPMENT

Members may install generating equipment to serve as a standby source of electricity to supply all or a part of the Member's load in the event of an interruption in the supply of electricity from NHEC. The Member's interconnection shall be arranged so that no electrical connection can occur between NHEC's service and the Member's standby source of supply. The standby source shall be controlled through the use of a double throw switch, (Refer to Construction Standard DPS1 located on page 56) installed in a manner acceptable to NHEC and designed to prevent the possibility of any electrical connection between NHEC's normal electrical supply and the Member's standby source. At NHEC's discretion, the Member's standby source may be allowed to connect with NHEC's supply provided certain conditions set forth by NHEC are addressed by the Member.

ATTENTION:

You must contact New Hampshire Electric Co-op BEFORE breaking the seal to remove any electric meter that is served by NHEC.

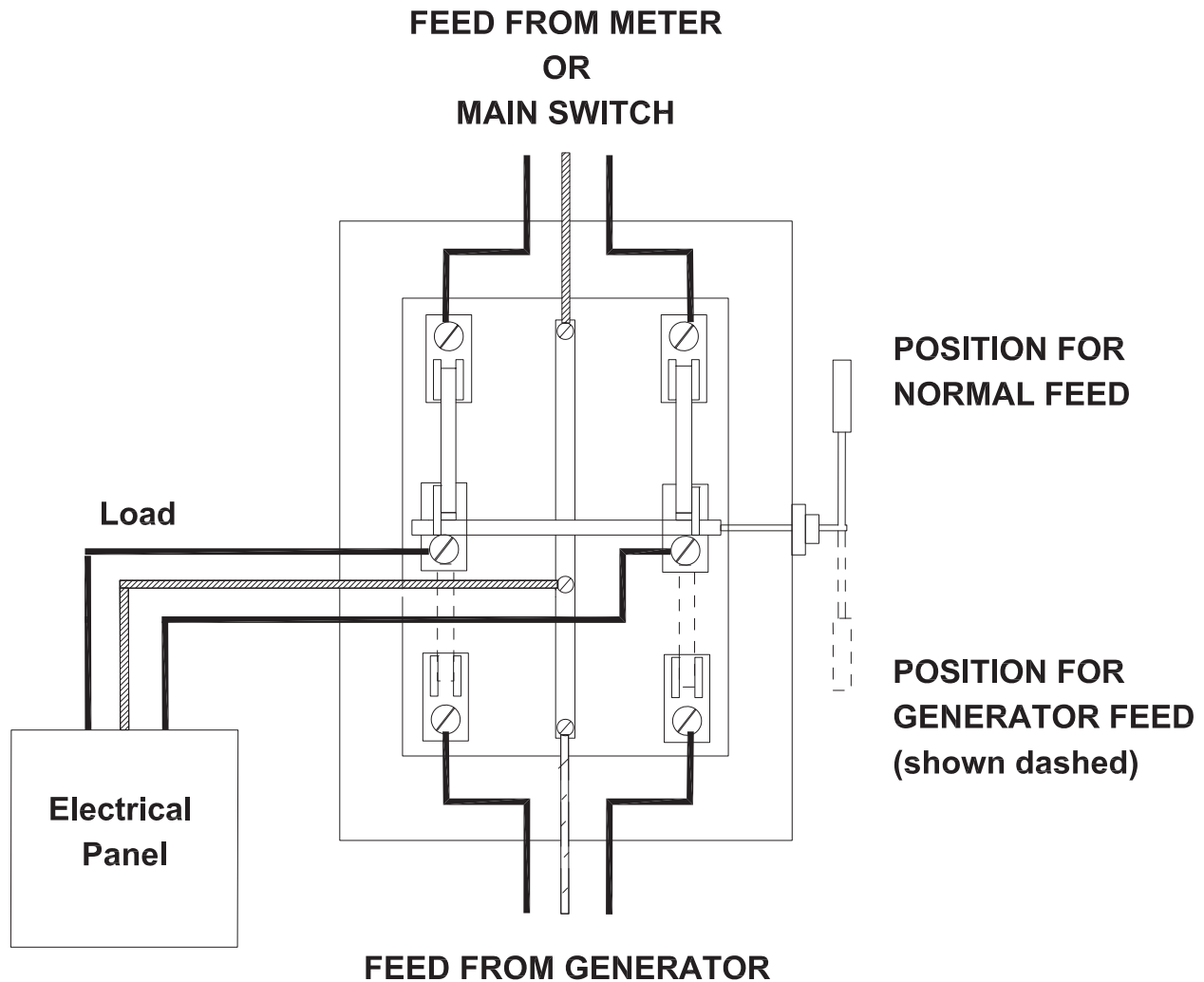

NOTES:

- 1.) Typical double-pole throw switch installation for use with a back-up generator.
- 2.) NHEC recommends that only those circuits needed in an emergency (i.e.: oil burner, one lighting circuit, etc.) be isolated in a separate electric panel, as most generators are not large enough for the load demanded by all your household appliances. As illustrated, this electric panel can be fed from either your main switch or the generator.
- 3.) If the generator is large enough to carry your entire load, the main switch may be connected to the load side of the double pole-double throw switch. The feed to this switch would then be from your generator or directly from our meter.
- 4.) NHEC urges you to contact a qualified electrician or the supplier of the generator to determine the operating limits of the unit you purchase.
- 5.) Please notify NHEC at 1-800-698-2007, if and when you install a back-up generator, so we can update our records to reflect your installation.
- 6.) You must contact New Hampshire Electric Co-op BEFORE breaking the seal to remove any electric meter that is served by NHEC.



Back-up Generator Registration Form

If you own an emergency / stand-by electric generator to supply power during outages, it is critical for your safety and the safety of New Hampshire Electric Co-op line crews that your equipment be properly installed and that the Co-op is aware that you have a generator. Please fill out the following form so that we can update our records to reflect your installation.

NHEC Account Information

Today's Date _____ Phone Number _____

Name _____

Address _____

Account Number _____

Generator Information

Generator Size (In Watts) _____ Brand Name _____

Installation Date (Month & Year) _____ Fuel Type _____

Transfer Switch? Yes ___ No ___ (If Yes) Type: Automatic ___ Manual ___ Model _____

Installation by Licensed Electrician? Yes ___ No ___ Inspection by Licensed Electrician? Yes ___ No _

NHEC Use

Reviewed By _____

Record Updated _____

Follow-up _____

Return To:

Generator Registration
New Hampshire Electric Cooperative
579 Tenney Mountain Hwy.
Plymouth, NH 03264

Questions:

Telephone: 1-800-698-2007
Email: Energy@nhec.com

Section 7: Interconnection Facility Installations and Electric Vehicle (EV) Charging Equipment

NET METERING

NHEC supports the development of member-sited renewable energy generation and storage facilities (referred to herein as an interconnection facility) by providing net metering, which is enabled by the installation of a bi-directional meter that allows you to offset your electricity requirements and to export surplus energy into our distribution system.

If you are planning to install an interconnection-facility and connection to NHEC's grid, you must receive approval from us.

NHEC's Net Metering Application form can be found at: [Solar & Net Metering](#)

Please begin with the following steps below:

1. Read NHEC's Terms and Conditions in particular Section X. Net Metering.
2. Review the Net Metering Rates in NHEC's Schedule of Rates.
3. Once you finalize your interconnection-facility plans, fully complete and submit Step 1 – Net Metering Interconnection-Facility Application Forms.
4. If you have a competitive power supplier, we strongly recommend contacting them to learn of their net metering policy prior to facility constructions.
5. Net and production meter sockets are required to be labeled with red placards and white writing with the language as directed on the interconnection application, step 2, page 1.
6. The production meter socket needs either:
 - Integral main breaker
 - Utility accessible disconnect directly adjacent to or within reach of the production meter
7. The production meter needs to meet the requirements specified in Section 2 Metering, Clearance requirements. For propane device clearances, reference SP-4, a minimum of 10' from storage or regulator.
8. Production meter wiring requires utility power on the load side and PV on the line side.

RESIDENTIAL OFF-PEAK ELECTRIC VEHICLE CHARGING STATION PROGRAM

The Residential Off-Peak Electric Vehicle Charging Station Program combines incentives for the installation of new Level 2 electric vehicle charging stations with an attractive EV Off-Peak Rate. In

addition to the Off-Peak Rate, NHEC will provide participants with an incentive for the installation of up to two Level 2 charging stations.

The Residential Off-Peak Electric Vehicle Charging Station Program application form, Instructions and Residential EV Charging Terms & Conditions can be found at:

[Electric Vehicle Charging | New Hampshire Electric Co-op](#)

Important information:

1. All projects must be pre-approved before installation begins.
2. Participation in the Off-Peak Charging program requires the installation of a UL approved meter socket to accommodate an NHEC monitoring meter that will record off-peak and on-peak kWh usage.
3. Members with existing interconnected net metered systems at their property will require a separate electrical account for the EV meter and will be required to pay a design fee.
4. It is very important that you share a copy of the simplified wiring diagram with your electrical contractor to ensure proper installation of the secondary meter socket.
5. EV meter sockets are required to be labeled with a red placards and white writing, stating "EV Charger".
6. EV chargers installed on a 120/208 volt service require a five terminal meter socket. The fifth terminal must be at the nine o'clock position and connected to the socket neutral bus conductor. The fifth terminal neutral bus conductor must be a grounded conductor and connected to the house service. This fifth terminal conductor cannot be an equipment ground.

Sample Wiring Diagram for Electric Vehicle Charging Stations

Electric Vehicle Service Equipment (EVSE) Sample Diagram *

Disclaimer - This sketch is provided as a sample for general guidance and illustrative purposes only. The sketch is **not intended to provide a National Electric Code (NEC) compliant electrical design or directives for full NEC compliance - that is the responsibility of your qualified and licensed electrician. The installation must comply with NH Electrical Cooperative standards and Terms & Conditions.*

Standard EVSE

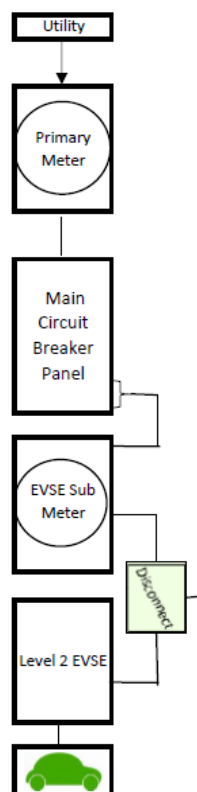

EVSE with Net Metering

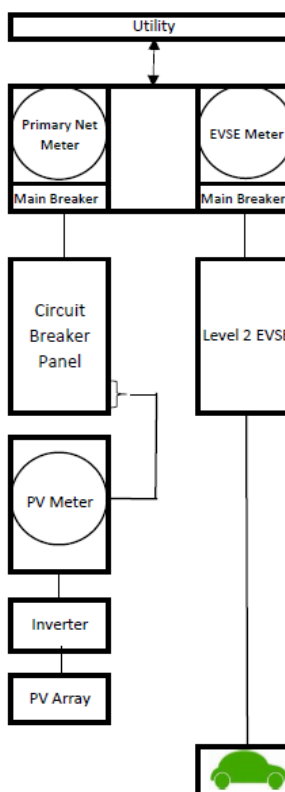

The optional installation of the disconnect illustrated above is strongly advised if you wish to de-energize your EVSE

Section 8: Glossary

Clearance

A set distance between two objects.

Common Ground Point

The conductor used to connect the grounding electrode to the equipment grounding conductor and/or to the grounded conductor of the circuit at the service.

Conduit

A listed or approved pipe with a smooth interior surface to permit easy drawing-in of electrical conductors. A conduit may be metallic or non-metallic, depending on its usage, in accordance with codes and standards.

Corrosion Inhibitor

Electrical joint compound used to retard oxidation of electrical connections.

Drip Loop

A loop formed in overhead secondary conductors at the weatherhead, to prevent the entrance of water into the service entrance conduit and equipment.

EV

Electric vehicle

Ground

Connected to or in contact with earth or connected to some extended conductive body that serves instead of the earth.

Guy

A cable or brace used to relieve the strain of overhead conductors on masts and poles.

Key box

A permanently installed, locked box with keys enclosed, mounted on the outside of a building, for accessing the customer's premises to read, install, service or remove the utility's meters and/or electrical equipment during reasonable working hours.

Listed

Equipment or material accepted by a nationally recognized testing laboratory, inspection agency, or other organization concerned with product evaluation.

Manual Circuit-Closing Block

A provision for paralleling the meter circuit, allowing the meter to be removed without interrupting service to the member.

Meter Equipment

Any equipment associated with measuring electric energy.

Meter Jaw

A spring-loaded receptacle inside a meter socket which connects the terminals of a meter to the source or load conductors of the service.

Meter Socket

The mounting device for socket type meters, consisting of meter jaws, connectors, an enclosure and in permanent installations an integrated main circuit breaker is required.

Mobile Home

A house trailer serving as a permanent home.

Modular Home

Also referred to as a manufactured home. A home designed with standardized units or dimensions and manufactured in a factory type facility.

Municipal, State Inspector

The qualified representative of a city or the state, authorized to inspect electrical service installations on their behalf.

NEC

National Electrical Code. Safety provisions for the installation of electrical equipment and conductors in buildings and other structures, published by the National Fire Protection Association.

NEMA

National Electrical Manufacturers Association. A trade association which publishes standards for manufacturers of electrical equipment, including enclosures and racks.

NESC

National Electrical Safety Code. Safety provisions for the installation, operation, and maintenance of electric supply and communication lines, published by Institute of Electrical and Electronics Engineers.

Neutral

The grounded conductor in a single-phase, three-wire or three-phase or three-phase, four wire system. The service conductor at zero potential to ground.

NHEC

New Hampshire Electric Cooperative

Point of Attachment

On overhead services, the point at which the utility's service line is attached to the customer's structure.

Point of Delivery

The point where the utility's service line and the customer's system are interconnected.

Seal

A locking device to secure a meter or service entrance equipment to assure safety and security.

Select Backfill

Native soil or soil brought in from another area, free from sharp objects, rocks, scrap building material and corrosive material.

Self-Contained

In reference to meter sockets, a device designed and rated to continuously carry the entire capacity of the service. The maximum self-contained meter socket current rating typically used is 400 amperes (also called a single-phase Class 320 A Meter).

Service Line

Conductors from the utility's system to the customer's point of delivery. A service line can be overhead or underground.

Service Entrance Conductor

On overhead services, conductors which extend between the customer's meter socket and the point of delivery.

Service Entrance Equipment

Service conduit, conductors, weatherhead, meter base, enclosures, service disconnect and service panel.

Service Mast

The conduit above the meter used to provide mechanical protection for the service conductors and to support the service drop from the utility.

Temporary Service

An electrical service installed by the utility to provide power to a customer on a temporary basis (less than one year).

UL

Underwriters' Laboratories. A recognized test laboratory which lists materials it has tested and accepted.

Underground Facilities

Any material or equipment that is integral to the underground distribution system.

Weatherhead

A simple underground-overhead fitting which provides a cap or a roof for the vertical conduit to prevent rain from entering it. Its use is restricted to connecting underground secondary cables to overhead secondary lines or service wires.

Ways to Save – Money & Energy

New Hampshire Electric Cooperative provides information, guidance, and incentives on energy efficient improvements for Commercial and Residential Members. Complete details can be found online at www.nhec.com

Residential

ENERGY STAR® Homes - New Construction

A National Effort to make new homes perform better when it come to Energy Efficiency

Home Performance with ENERGY STAR®

Get a comprehensive home energy audit to identify the inefficiencies in your home - with incentives offered to fix them.

Low Interest financing options available.

Home Energy Assistance

HEA assists with no-cost energy efficiency improvements for income qualified members

Electric Vehicles and Charging Stations

Level 2 EV charging station rebates Electric vehicle rebates for:

- Plug-in Hybrid Vehicles
- Battery Electric Vehicles
- Motorcycles

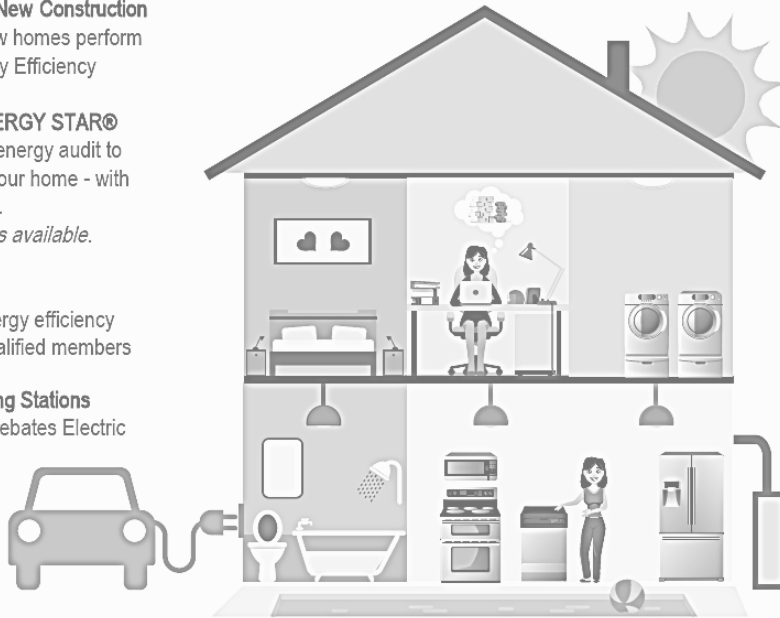

Renewable Energy - Net Metering

NHEC offers net metering to members wanting to interconnect their renewable energy generation and storage systems to our distribution grid.

Appliance Rebates:

- Dehumidifier
- Clothes Washers
- Clothes Dryers
- Refrigerator
- Room Air Conditioners
- Room Air Purifier
- Pool Pumps
- Sense Home Energy Monitor

HVAC Rebates:

- Heat Pump Water Heaters
 - Air Source Heat Pumps
 - Mini-Split Heat Pumps
 - Geo-thermal Heat Pumps
- Low interest financing options available*

Businesses & Towns

LED Lighting

Convert to LED lighting with NO OUT-OF-POCKET EXPENSE with our incentives and On-Bill Financing.

Heating & Cooling

Electric heat pumps heat and cool with up to three times the efficiency of fossil fuels. Incentives available on per ton capacity of installation

Renewable Energy - Net Metering

Net metering is offered to towns and businesses that want to interconnect their renewable energy generation and storage systems to our distribution grid.

Electric Vehicle Charging

Install Level 2 (or higher) chargers with sizable incentives offered



Building Weatherization

Improve the comfort and energy efficiency of your space with incentives offered to help offset costs of weatherization measures.

Commercial Kitchen Equipment

Instant rebates available for purchase of new, energy-efficient equipment from specific distributors.

Custom Incentives

Variety of incentives available for Lighting Controls, Variable Frequency Drives, Compressed Air and other process equipment.

Restrictions may apply, please see program details on our website prior to project start or purchase.

For more information call NHEC at 1-800-698-2007